

**MUTOH**

# XPJ-C641SR-P

## Operation Manual

Operations and Maintenance Methods

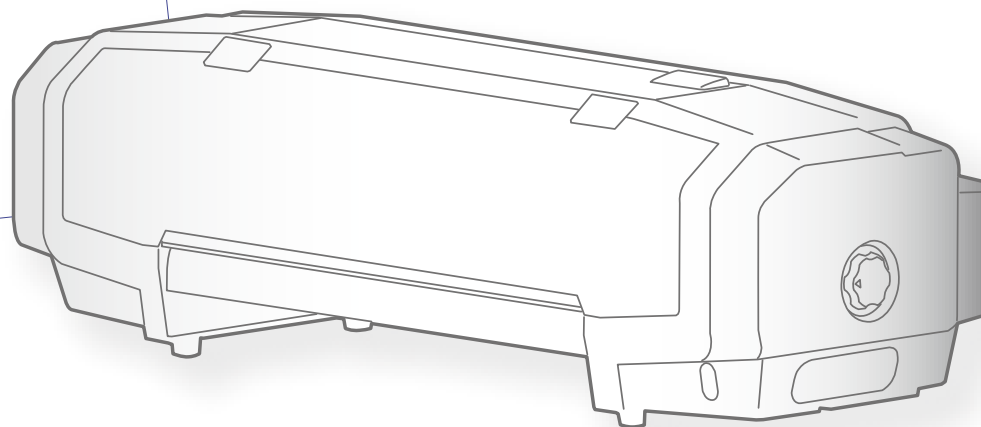

XPJC641SRPE-A-01

## Important Notice

---

### For Users in Europe

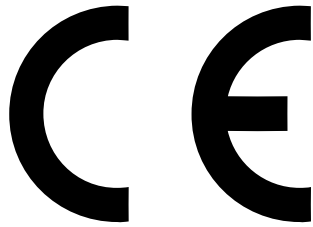

The CE marking is a mandatory European marking for certain product groups to indicate conformity with the essential health and safety requirements set out in European Directives.

By affixing the CE marking, the manufacturer, his authorized representative, or the person placing

the product on the market or putting it into service ensures that the item meets all the essential requirements of all applicable EU directives and that the applicable conformity assessment procedures have been applied.

### For Users in the United States

This equipment has been tested and found to comply with the limits for a Class A digital device, pursuant to Part 15 of the FCC Rules. These limits are designed to provide reasonable protection against harmful interference when the equipment is operated in a commercial environment. This equipment generates, uses, and can radiate radio frequency energy and, if not installed and used in accordance with the instruction manual, may cause harmful interference to radio communications.

Operation of this equipment in a residential area is likely to cause harmful interference in which case the user will be required to correct the interference at his own expense.

### CAUTION

Use of controls or adjustments or performance of procedures other than those specified herein may result in radiation exposure.

---

Microsoft® and Windows® are either registered trademarks or trademarks of Microsoft Corporation in the United States and/or other countries.

VerteLith™ is trademark of MUTOH INDUSTRIES LTD.

Company names and product names that appear in this Guide are registered trademarks or trademarks of the respective companies.

---

- Unauthorized copying or duplication of the whole or part of the contents of this Guide is prohibited.
- Every care has been taken in writing the contents of this Guide, but please contact MUTOH or the dealer you purchased the product from if you find any unclear, erroneous or otherwise unsatisfactory content in the Guide.
- Please be aware that MUTOH will not be liable in any way for failures or accidents that result from handling or operating the printer according to any procedures other than those set forth in this Guide.

## For Safe Use 7

Safety Precautions .....	8
Electrical shock/ short circuit/ fire hazards.....	9
Installation.....	11
Handling.....	12
Ink and waste fluid .....	14
Warning labels .....	15
Instruction Labels .....	16

## Before Use 17

Printer main components / Functions.....	18
Front view .....	18
Rear view .....	20
Printer control panel .....	21
Connecting to a Computer .....	23
System configuration of this product.....	25
Launching/ Opening/Exiting MSM.....	26
Launching MSM.....	26
Displaying MSM.....	26
Displaying remote panel .....	27

Changing an IP address .....	28
Exiting MSM .....	35

Launching VerteLith .....	36
---------------------------	----

What you can do on this machine .....	37
---------------------------------------	----

Printing area.....	38
--------------------	----

Supported media .....	39
-----------------------	----

Media Size .....	39
------------------	----

Media handling cautions .....	40
-------------------------------	----

Precaution on storing media after use .....	40
---	----

Precautions.....	41
------------------	----

Please use this printer regularly.....	41
--	----

Please handle ink cartridge carefully .....	41
---	----

Please conduct maintenance regularly.....	42
---	----

Some parts need to be replaced periodically .....	42
---	----

## Basic Operations 43

Printing workflow.....	44
------------------------	----

Powering ON / OFF .....	45
-------------------------	----

Turning the power ON .....	45
----------------------------	----

Turning the power OFF.....	46
----------------------------	----

Sleep Mode .....	<b>47</b>	High-Capacity ink pack adapter .....	<b>93</b>
To start and end sleep mode .....	47	When using the high-capacity ink pack adapter for the first time... 93	
Replace the adapter's plug .....		93	
Loading media into the machine .....	<b>51</b>	Adjust head height.....	<b>94</b>
Loading a roll media into the printer.....	51	About head height .....	94
Loading a cut sheet into the machine.....	56	Advanced settings .....	<b>96</b>
Nozzle check and cleaning .....	<b>57</b>	Set up auto cutting.....	96
Run a nozzle check.....	57	Set up vacuum fan .....	99
Head cleaning .....	61	Specify the heater setting .....	101
Calibrating your printer .....	<b>63</b>	Cooling down setting .....	103
Print quality calibration ("Adjust Print") .....	63	Specify the ink drying time .....	105
Media Feed Adjustment.....	71	Roll Length Manage menu .....	107
Start printing .....	<b>78</b>		
Pause / Resume a print job .....	<b>84</b>		
Cancel a print job .....	<b>85</b>		
Cancel printing from the machine .....	85		
Cancel printing from the computer .....	85		
Feed/ Rewind media .....	<b>87</b>		
Cut the media .....	<b>89</b>		
Cut from the control panel .....	89		
Cut from the computer.....	90		
Cut manually.....	91		
Cut automatically .....	92		

## Cutting Workflow

## 109

Cut Preparation.....	<b>110</b>
Preparation flow for cutting .....	110
Install a blade on the blade holder .....	111
Adjust blade depth.....	113
Install the blade holder into the machine .....	115
Run a test cut .....	118
Adjust the contour cutting position.....	126
Cutting types .....	129

Create a cutting data .....	130
Types of crop marks .....	131
Media orientation auto-detection.....	132
<b>Print and cut separately .....</b>	<b>133</b>
Operation flow.....	133
Step1. Print .....	134
Step2. Cut .....	140
<b>Print &amp; Cut.....</b>	<b>142</b>
<b>Cut only .....</b>	<b>144</b>
<b>Optimize cut quality .....</b>	<b>146</b>
Set cutting conditions.....	146
Cut quality of curves .....	151
Cut scale adjustment.....	153

## Maintenance **158**

About Maintenance.....	159
<b>Check and replace ink.....</b>	<b>161</b>
Check the ink level .....	161
When an ink is nearing replacement.....	162
Replacing with a new ink cartridge .....	163
<b>Emptying waste ink tank .....</b>	<b>168</b>

<b>Cleaning each part.....</b>	<b>171</b>
Head cleaning .....	171
Cleaning each part of the machine.....	174
Put the machine in the CR maintenance mode .....	175
Cleaning the parts around the print head .....	177
Cleaning the cleaning wiper.....	180
Cleaning the parts around the cap unit .....	182
Cleaning of color sensor.....	184
Cleaning the blade holder.....	186
Cleaning the blade for contour cutter.....	188
Cleaning inside the machine .....	189
<b>Replacing consumable parts .....</b>	<b>191</b>
Replacing the flushing box pad.....	192
Replacing the blade for sheet cutter .....	195
Replacing the adapter's plug for high-capacity ink pack adapter ..	197
Replacing the cutting mat.....	201
Replacing the blade for contour cutter.....	203
Replacing the blade holder.....	204
Replacing the cleaning wiper.....	205
<b>Transport and long-term storage .....</b>	<b>207</b>
Transporting the machine.....	207
Performing initial ink charging.....	213
When not using the machine for a long time.....	218

## **When problems occur** **219**

Messages and Error Messages .....	<b>220</b>
When it appears .....	220
Error messages and solutions .....	224
Smartchip Recovery .....	228
Troubleshooting .....	<b>229</b>
Installation and initial setup-related trouble .....	229
Printer operation trouble .....	231
Media-related trouble .....	232
Printing-related trouble .....	235
Cutting-related trouble .....	239
The media is jammed .....	242

## **Appendix** **244**

Specifications of this product .....	<b>245</b>
Optional accessories / Consumable supplies .....	<b>247</b>
Revision history .....	<b>248</b>

# For Safe Use



# Safety Precautions

## Safety Symbols



In this document, the following symbols are used for the instructions that must be followed to avoid risk of harm to human health or damage to the property.

Please read and understand the meaning of each symbol and ensure the proper use of the product.



■ The following classifications indicate hazards or damage that could result from ignoring instructions or incorrect handling.

 <b>Warning</b>	Failure to follow the instructions could result in serious injury or death.
 <b>Caution</b>	Failure to follow the instructions could result in minor injury or damage to the whole or part of the product.

■ The following symbols indicate precautions that must be followed.

	An action that must be avoided.
	An important instruction that must be followed.

■ Other symbols

 <b>Important !</b>	Provides information that require special attention or should be followed.
 <b>Note</b>	Provides supplemental or reference information.
	Indicates the link to the reference section.

### Note









For the name of each part marked with warning or caution symbols, see “Printer main components / Functions” on page 18 on the XPJ-C641SR-P operation manual.



Safety Precautions

## Electrical shock/ short circuit/ fire hazards

 **Warning**

	<p><b>Do not install this product in a location with high humidity and dust.</b> This could result in an electrical shock or fire.</p>		<p><b>Make sure to use a designated power socket.</b> Failure to do so could result in an electrical shock or fire.</p>
	<p><b>Do not use a damaged power cord.</b> This could result in an electrical shock or fire.</p>		<p><b>Plug the power cord into the wall outlet.</b> Do not use power strips. This could generate heat, resulting in fire..</p>
	<p><b>Do not connect or disconnect the power plug with wet hands.</b> This could result in an electrical shock.</p>		<p><b>Plug the power cords into the wall outlet that has the earth connection and make sure to connect the earth.</b> If the earth is not connected, an electrical shock or fire may occur.</p>
	<p><b>Do not connect an earth wire to the following places:</b></p> <ul style="list-style-type: none"> <li>• <b>Gas pipe</b> It has potential risks of fire or explosion.</li> <li>• <b>Earth wire of telephone cables or lighting rods</b> Large current may flow when the lightning strikes.</li> <li>• <b>Water pipe or faucet</b> It may not work properly if a plastic pipe is connected to the pipe.</li> </ul>		<p><b>Make sure to connect an earth wire to the earth connection that meets the following requirements:</b></p> <ul style="list-style-type: none"> <li>• <b>Earth terminal of power socket.</b></li> <li>• <b>An earth wire with a copper plate which is buried at 650 mm or more in the ground.</b></li> </ul>
			<p><b>Keep ink away from fire or heat source and store in a cool, dark place.</b></p>

## For Safe Use

Before Use

Basic Operations









Cutting Workflow

Maintenance

When problems occur

Appendix





### Safety Precautions

	<p><b>Do not insert or drop metal or flammable objects into the printer through openings such as vent.</b> This could result in an electrical shock or fire.</p>		<p><b>Be sure to use the designated power cords.</b></p> <ul style="list-style-type: none"> <li>• Failure to do so could result in an electrical shock or fire. For the designated power cord, please contact your local MUTOH dealer.</li> <li>• The power cord should have the protective ground terminal and make sure to plug in securely.</li> <li>• Use the power cords which meet the safety standard, voltage and plug shape of the country to use this product.</li> </ul>
	<p><b>Do not block the vent on the product with cloth or other materials.</b> If covered, the inside the product gets hot, resulting in fire.</p>		
	<p><b>Never open the covers securing with screws.</b> This could result in an electrical shock or damage to the printer.</p>		
	<p><b>Ensure that no moisture enters the product.</b> This could result in an electrical short circuit.</p>		<p><b>Make sure to follow the instructions on this guide to connect the power cord or cables.</b> Failure to do so could result in fire.</p>
	<p><b>If foreign objects or liquid accidentally entered the inside of the printer, do not use it.</b> This could result in an electrical shock or fire. Immediately power off the printer and disconnect the power plug from the outlet. Then contact the MUTOH customer support.</p>		
	<p><b>Follow the precautions below when handling the power cord.</b></p> <ul style="list-style-type: none"> <li>• Do not modify power cords.</li> <li>• Do not place heavy objects on power cords.</li> <li>• Do not bend, twist, or pull on power cords.</li> <li>• Do not route power cords near heating equipment.</li> </ul>		<p><b>Follow the precautions below when handling the power plug.</b></p> <ul style="list-style-type: none"> <li>• Do not allow dust or foreign objects to accumulate around the power plug.</li> <li>• Firmly insert the power plug into the wall outlet.</li> </ul> <p>Incorrect handling could result in fire.</p>

Safety Precautions

# Installation

## Warning

	<p>Choose the location which satisfies the requirements below:</p> <ul style="list-style-type: none"> <li>• The floor must be level.</li> <li>• Avoid vibration from the neighboring devices.</li> <li>• Low humidity and free from dust.</li> <li>• Less chance of temperature and humidity changes.</li> <li>• Avoid direct sunlight.</li> <li>• Avoid water.</li> <li>• Avoid direct air onto the printer.</li> <li>• Low levels of electromagnetic waves.</li> </ul>		<p>Install the product in a location where ventilation can be carried out. <b>Keep the work area well-ventilated.</b></p> <p>Odor of the ink could have adversely impact on health. If you experience headache, fatigue or dizziness, stop your work and immediately get to fresh air. If nausea persists, seek medical advice.</p>
	<p><b>This equipment is not suitable for use in locations where children are likely to be present.</b></p>		
	<p>Before taking out the product from the packaging box, make sure to remove the plastic sheet wrapped around the product first. Failure to do so could cause slip or damage to the product.</p>		

## Caution

	<p>At least two people are required for moving this product. When moving, keep the product level.</p>		<p><b>Do not tilt the product.</b> The ink inside the product may spill. MUTOH cannot guarantee that the printer can run properly.</p>
--	---	--	--

## For Safe Use

Before Use

Basic Operations

Cutting Workflow

Maintenance



When problems occur

Appendix







### Safety Precautions

## Handling

### Warning

	<b>Do not sit on or place heavy objects on the product.</b> Failure to do so could result in injury from a fall.
	<b>Do not touch the moving parts.</b> This could cause injury or damage to the product.
	<b>In case you need to move the product after ink was filled, move it slowly to avoid impact and risk of ink leakage.</b>

### Caution

	<b>Do not attempt the following actions during ink charging:</b> <ul style="list-style-type: none"><li>• Power off the printer.</li><li>• Disconnect the power cord.</li><li>• Open the front cover or the maintenance cover.</li><li>• Put the media fixing handle in unlock position.</li></ul>		<b>Do not touch the cleaning wiper and the print head cap unit with bare hands when cleaning the wiper.</b> If finger oil gets on this, head cleaning cannot be performed properly.
	<b>Do not use the media fixing handle while in printer initialization or printing.</b> The print head can interfere with the pinch rollers and cause damage.		<b>Do not touch the media feed slot, platen and media guide while the heater is in operation.</b> These parts get hot and could cause burn injury.
	<b>Do not use volatile chemicals such as thinner, benzine or alcohol for cleaning.</b> This will damage the paint on the printer.		<b>Do not touch the media guide while printing.</b> The media guide becomes hot and you could get burn injuries.

## For Safe Use

Before Use

Basic Operations





Cutting Workflow

Maintenance

When problems occur

Appendix



### Safety Precautions

	<b>Do not push the tab on the cutter holder too hard or release suddenly.</b> There is a spring under the cutter so that the cutter may jump out from the holder.		<b>Do not touch the blade edge.</b> This will cause injury.
	<b>Never touch the print head nozzles when cleaning the parts around the print head.</b> This could damage the print head.		<b>Immediately after printing, the media guide gets hot. Allow it to cool down enough to do the work.</b>
	<b>Before moving this printer, always empty the waste ink tank even moving short distance.</b> Failure to do so may result in damage to the product.		





Safety Precautions

## Ink and waste fluid

### Warning

	Make sure to read the Safety Data Sheet (SDS) before using ink cartridges for the first time.
	Store ink cartridges and waste fluids in a cool, dark place and avoid direct sunlight. Keep away from <ul style="list-style-type: none"> <li>• children's reach</li> <li>• fire and heat</li> </ul>
	When disposing of ink, waste fluid collected from the printer, or containers and paper towels with ink adhered, be sure to follow the instructions of industrial waste disposal contractors, related laws, and local regulations to dispose of them.

### Caution

	Follow these precautions when handling ink cartridge: <ul style="list-style-type: none"> <li>• Do not disassemble</li> <li>• Do not drop or hit</li> </ul> This could lead to ink leakage.		<b>Use MUTOH genuine ink.</b> This printer is designed to deliver best performance by using MUTOH genuine ink. The use of non-genuine ink may affect the printer as well as print quality. This is not covered by the warranty.
	<b>Use inks within its shelf life.</b> <ul style="list-style-type: none"> <li>• Using an expired ink could result in damage to the printer.</li> <li>• When expired, replace with a new one even if ink remains in the ink bag.</li> <li>• Dispose of expired ink as industrial waste. Put the emptied ink cartridge in a plastic bag and dispose of it according to the local regulations.</li> </ul>		
	<b>When handling ink, wear protective gloves, glasses and masks.</b> <b>When handling ink cartridges, avoid skin or eye contact with ink. If in eyes or on skin, immediately flush with running water.</b> If left untreated, it could cause bloodshot eyes or mild inflammation. If there is any abnormality, seek medical advice immediately.		

## For Safe Use

Before Use

Basic Operations

Cutting Workflow

Maintenance

When problems occur

Appendix

### Safety Precautions

## Warning labels

Warning labels are affixed to the hazardous area of the product. Read and follow the instructions on the labels. In case the warning labels came off or get dirty, please contact your local MUTOH dealer for replacement.

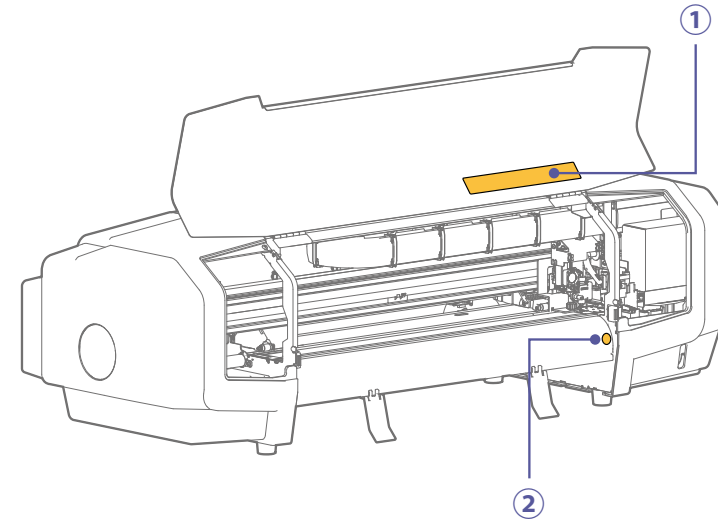

Type of labels	Name / Meaning
<p>①</p>	<p><b>Cut Hazard Label for Cutter</b></p> <ul style="list-style-type: none"> <li>Do not insert your fingers around the cutter. The cutting blade may injure your fingers.</li> </ul>
<p>②</p>	<p><b>Do Not Put Hand Label</b></p> <ul style="list-style-type: none"> <li>Contacting with carriage could cause injuries.</li> </ul>

## For Safe Use

Before Use

Basic Operations

Cutting Workflow

Maintenance

When problems occur

Appendix

### Safety Precautions

## Instruction Labels

Instruction labels are affixed where special attention for operating this product is required. The contents of each label are shown here.

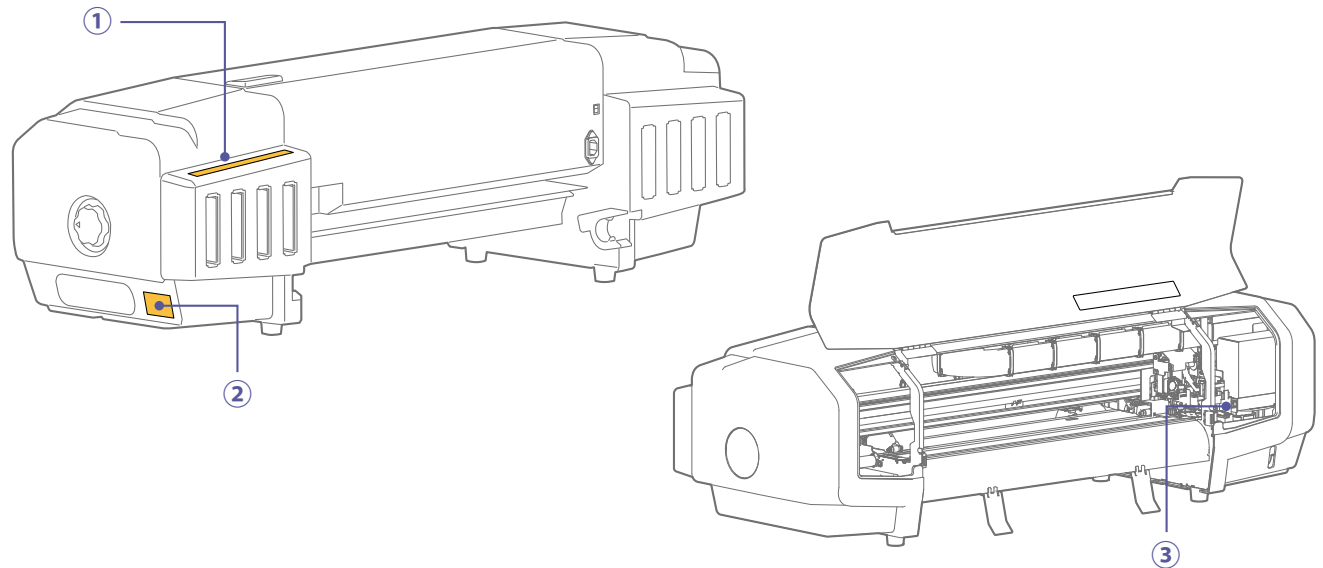

Type of labels	Name / Meaning
<p>①</p>	<p><b>Ink Color Label</b></p> <ul style="list-style-type: none"> <li>Insert the correct color of ink cartridge according to this label.</li> </ul>
<p>②</p> <p>◆When moving this product, always empty the waste ink tank . If ink splashes inside the waste ink tank while being moved, it can cause damage.</p> <p>◆本製品を移動するときは、廃液タンクを空にして下さい。 移動時に廃液タンク内でインクがはねると故障の原因となります。</p>	<p><b>Moving Instruction Label</b></p>
<p>③</p>	<p><b>ORIGIN Label</b></p> <ul style="list-style-type: none"> <li>The label indicates the origin position of the printer.</li> </ul>



# Before Use

Printer main components / Functions	18
Connecting to a Computer	23
System configuration of this product	25
Launching/ Opening/Exiting MSM	26
Launching Vertelith	36
What this product can do	37
Printing area	38
Supported media	39
Precautions	41

## Before Use

### Printer main components / Functions

## Basic Operations

Connecting to a Computer

## Cutting Workflow

System configuration of this product

## Maintenance

Launching/ Opening/ Exiting MSM

## When problems occur

Launching VerteLith

## Appendix

What you can do on this machine

Printing area

Supported media

Precautions

# Printer main components / Functions

## Front view

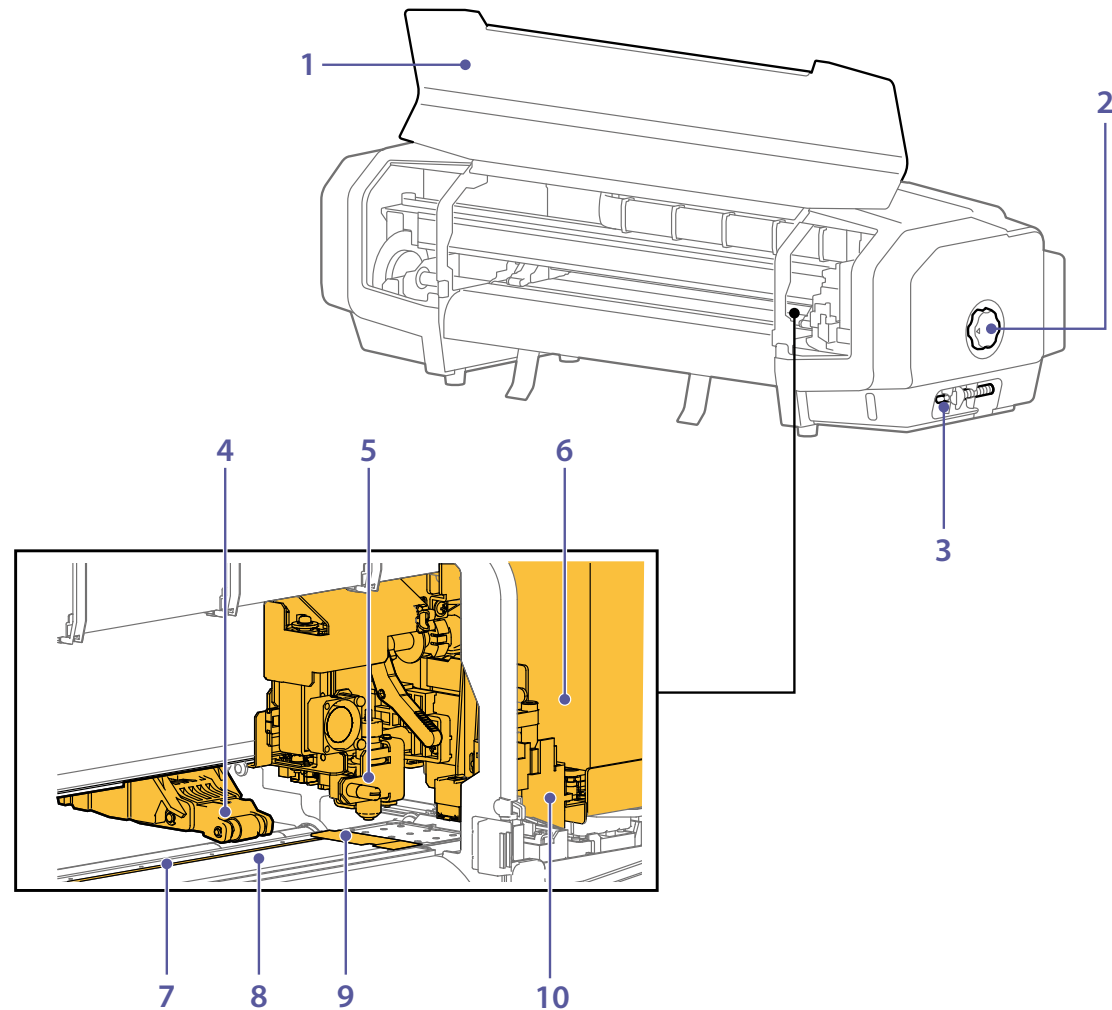

## Before Use

### Printer main components / Functions

## Basic Operations

### Connecting to a Computer

## Cutting Workflow

### System configuration of this product

## Maintenance

### Launching/ Opening/ Exiting MSM

## When problems occur

### Launching VerteLith

## Appendix

### What you can do on this machine

### Printing area

### Supported media

### Precautions

- |   |                            |  |
|---|----------------------------|--|
| 1 | <b>Front cover</b>         | Open when loading media or performing maintenance. |
| 2 | <b>Media fixing handle</b> | Turn the handle when loading or removing media.    |

### Important !!

Please make sure to do the following:

- Unlock the media fixing handle when you are not using the machine. If no printing or cutting is performed for 30 minutes or the machine was turned off while the media fixing handle is locked, the buzzer will beep and the error LED will turn on.
- After unlocking the media fixing handle, remove media from the machine. If you keep the media loaded in the machine, the carriage could contact the media during automatic cleaning.

- |    |                       |   |
|----|-----------------------|---|
| 3  | <b>Drain tube</b>     | Tube for draining waste ink into a container.                           |
| 4  | <b>Pinch roller</b>   | Hold down the media on the platen by using the media fixing handle.     |
| 5  | <b>Contour cutter</b> | Cut along the printed line.   |
| 6  | <b>Carriage</b>       | The print head and the cutter are installed on the carriage.            |
| 7  | <b>Cutting mat</b>    | Protect the cutting edge of contour cutter.                             |
| 8  | <b>Platen</b>         | Media is printed on here. It has a vacuum fan and heater inside.        |
| 9  | <b>Edge holder</b>    | Place it on the edge of the media to prevent media curl while printing. |
| 10 | <b>Sheet Cutter</b>   | Cut a roll media straight.  |

## Before Use

## Basic Operations

## Cutting Workflow

## Maintenance

## When problems occur

## Appendix

### Printer main components / Functions

Connecting to a Computer

System configuration of this product

Launching/ Opening/ Exiting MSM

Launching VerteLith

What you can do on this machine

Printing area

Supported media

Precautions

## Rear view

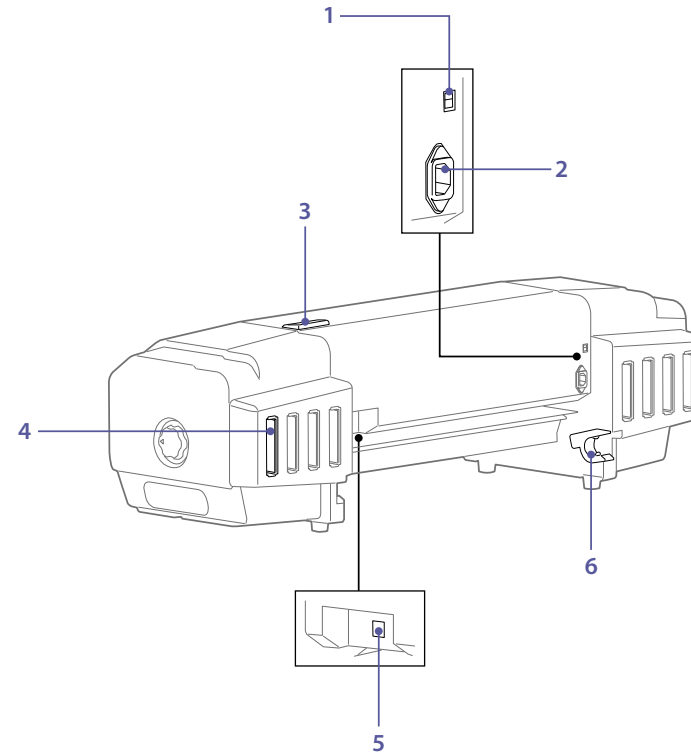

- |  |  |
|--|--|
| <b>1 Voltage switch</b>                    | Set the voltage switch depending on the voltage of the country or region that the machine is used.<br>☞ Startup Guide "Preparations" |
| <b>2 Power cord connector</b>              |  |
| <b>3 Printer control panel</b>             | ☞ "Printer control panel" P.21   |
| <b>4 Ink slots</b>                         | Insert an ink cartridge or a cleaning cartridge into these slots.  |
| <b>5 Network interface cable connector</b> | Connect an Ethernet cable.   |
| <b>6 Scroller holder</b>                   | Attach a roll media to the scroller and load it onto the holder.   |

## Before Use

### Printer main components / Functions

## Basic Operations

Connecting to a Computer

## Cutting Workflow

System configuration of this product

## Maintenance

Launching/ Opening/ Exiting MSM

## When problems occur

Launching VerteLith

## Appendix

What you can do on this machine

Printing area

Supported media

Precautions

# Printer control panel

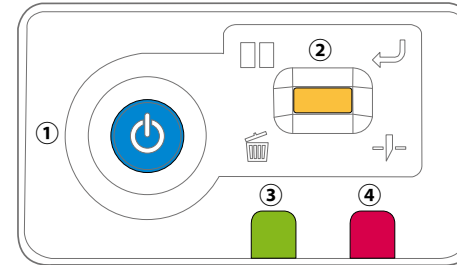

### Power button: :

- It lights on in blue when the power is on.

### Note

⏻ The symbol means standby. This printer consumes some power unless the power cord is disconnected. In this document, this state is referred to as the power being "off".



### Operation key

It has various function depending on the printer status

### While printing

- Short press: Pause/ resume printing
- Long press: Cancel printing (delete data)

### Ready-to-print state

- Long press: Cut the media.
- Short press twice: Print a nozzle check pattern.
- Short press, then long press: Begin the normal cleaning cycle.

### When waiting for confirmation when linked with MSM

- Short press: Confirm

### While warming up

- Short press: Forcibly start printing

### While cooling down

- Short press: Forcibly start printing

### While feeding media

- Short/Long press: Stop media feeding

### when an error occurs

- Short press: Stop the buzzer

**Before Use**

**Printer main components / Functions**

**Basic Operations**

**Connecting to a Computer**

**Cutting Workflow**

**System configuration of this product**

**Maintenance**

**Launching/ Opening/ Exiting MSM**

**When problems occur**

**Launching VerteLith**

**Appendix**

**What you can do on this machine**

**Printing area**

**Supported media**

**Precautions**

③



**Data LED :**

Green flashing indicates the machine is receiving or processing data.

④



**Error LED :**

• Red light or flashing indicates an error or warning occurs.

Before Use

Printer main components /  
Functions

Basic  
Operations

Connecting to a Computer

Cutting  
Workflow

System configuration of  
this product

Maintenance

Launching/ Opening/  
Exiting MSM

When problems  
occur

Launching VerteLith

Appendix

What you can do on this  
machine

Printing area

Supported media

Precautions

# Connecting to a Computer

## Important!

Make sure your computer meets the following requirements.

- OS: Windows 11, Windows 10
- CPU: Intel (R) Core (TM) i5 or more
- Memory: 16GB minimum
- Network: Ethernet network port

## Note

- The OS support period of software supplied from MUTOH conforms to the Microsoft support lifecycle policies.
- Please also check the system requirements of your RIP software.

**1** Connect the Ethernet cable to this product.

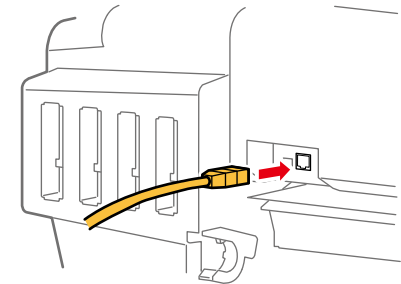

**2** Secure the Ethernet cable with the cable tie.

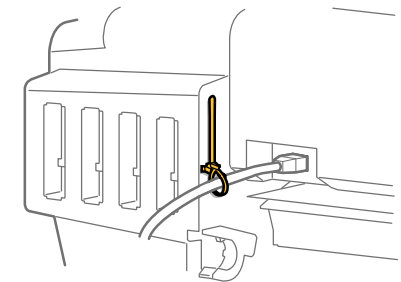

## Before Use

Printer main components / Functions

## Basic Operations

Connecting to a Computer

## Cutting Workflow

System configuration of this product

## Maintenance

Launching/ Opening/ Exiting MSM

## When problems occur

Launching VerteLith

## Appendix

What you can do on this machine

Printing area

Supported media

Precautions

**3** Connect the Ethernet cable to the computer.

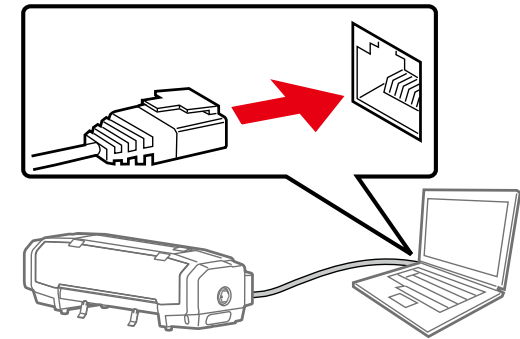

**4** Use MSM to assign the IP address, subnet mask and gateway.  
👉 ["Launching/ Opening/Exiting MSM" P.26](#)

### Note

- This illustration is an example of peer-to-peer connection between the printer and a computer. The connection method varies depending on your environment.
- If you are using the LAN connection, make sure that your printer and your computer are on the same subnet.



Before Use

Printer main components / Functions

Basic Operations

Connecting to a Computer

Cutting Workflow

System configuration of this product

Maintenance

Launching/ Opening/ Exiting MSM

When problems occur

Launching VerteLith

Appendix

What you can do on this machine

Printing area

Supported media

Precautions

# System configuration of this product

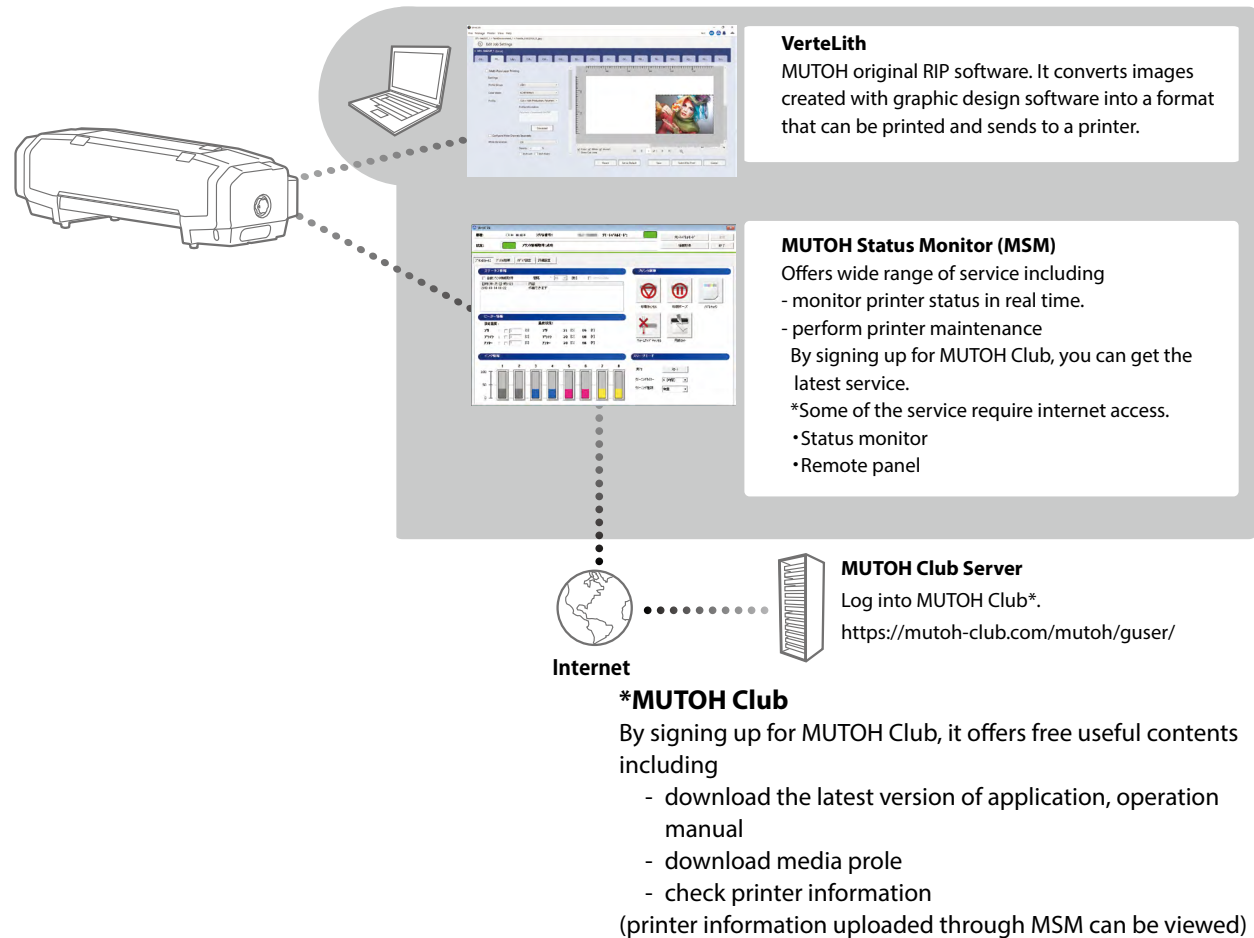

<Print Support Software>

To get the best out of this product, use MSM.

You can download the latest version of MSM from the MUTOH Club Server.

Before Use

Printer main components / Functions

Basic Operations

Connecting to a Computer

Cutting Workflow

System configuration of this product

Maintenance

Launching/ Opening/ Exiting MSM

When problems occur

Launching VerteLith

Appendix

What you can do on this machine

Printing area

Supported media

Precautions

# Launching/ Opening/Exiting MSM

## Launching MSM



Windows 11 / Windows 10

1. Double-click the MSM icon on the desktop.

### Note

Launching from the Start Menu of Windows

- Windows 11 / Windows 10

From the [Start] menu, click [All Programs] (or [All Apps]) - [MUTOH] - [MUTOH Status Monitor].

## Displaying MSM

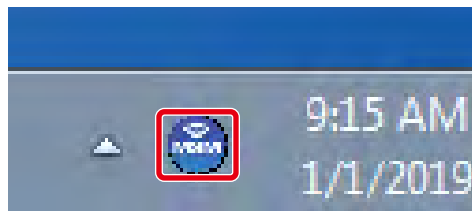

1. Double click the MSM icon in the task tray.

Before Use

Printer main components / Functions

Basic Operations

Connecting to a Computer

Cutting Workflow

System configuration of this product

Maintenance

Launching/ Opening/ Exiting MSM

When problems occur

Launching VerteLith

Appendix

What you can do on this machine

Printing area

Supported media

Precautions

## Displaying remote panel

The remote panel allows you to view the printer status or remotely operate your printer.

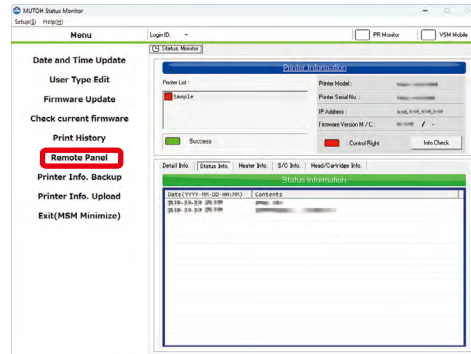

1. Click [Remote Panel].

- The remote panel opens.

Before Use

Printer main components / Functions

Basic Operations

Connecting to a Computer

Cutting Workflow

System configuration of this product

Maintenance

Launching/ Opening/ Exiting MSM

When problems occur

Launching VerteLith

Appendix

What you can do on this machine

Printing area

Supported media

Precautions

## Changing an IP address

After registering your printer, you can change the printer IP address from MSM.

1. Launch MSM.

Right click the MSM icon in the task tray and click [Printer Registration].

- The [Printer Registration] page opens.

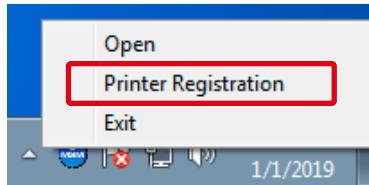

2. Click [Add].

**Note**

Before clicking the button, turn on the machine and connect it to the network on the same segment.

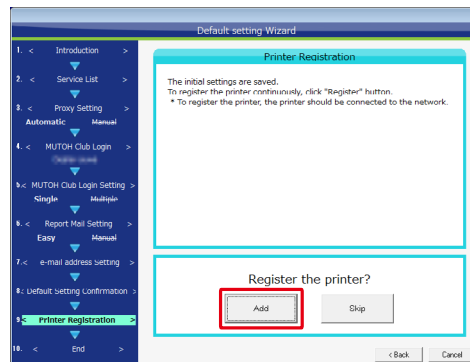

3. Click [Add].

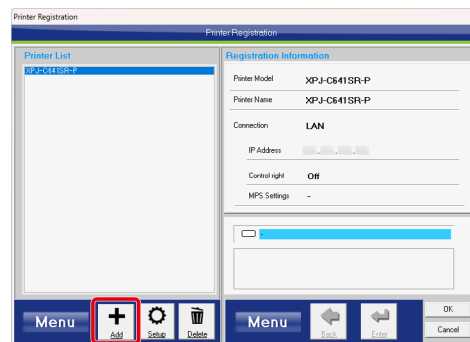

Before Use

Printer main components / Functions

Basic Operations

Connecting to a Computer

Cutting Workflow

System configuration of this product

Maintenance

Launching/ Opening/ Exiting MSM

When problems occur

Launching VerteLith

Appendix

What you can do on this machine

Printing area

Supported media

Precautions

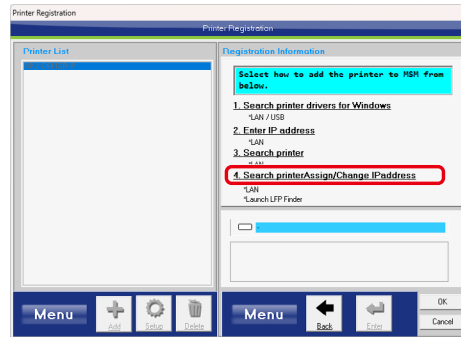

4. Click [Search printer Assign/Change IP address].

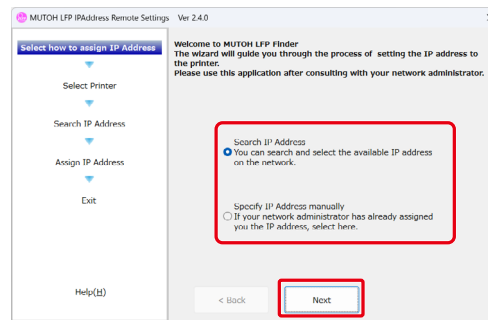

5. MUTOH LFP Finder appears. Select the method to assign IP address and click [Next].

☞ "When "Search IP Address is selected"" P.30

☞ "When "Specify IP Address manually" is selected" P.31

Before Use

Printer main components / Functions

Basic Operations

Connecting to a Computer

Cutting Workflow

System configuration of this product

Maintenance

Launching/ Opening/ Exiting MSM

When problems occur

Launching VerteLith

Appendix

What you can do on this machine

Printing area

Supported media

Precautions

## When "Search IP Address is selected"

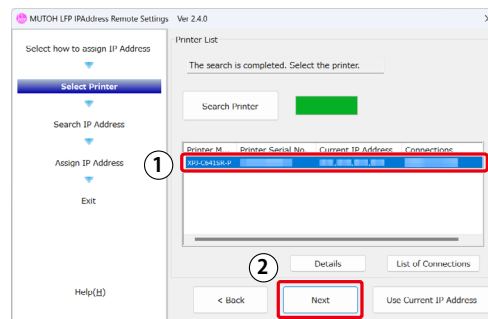

1. Select the machine you want to change the IP address (①), and click [Next] (②).

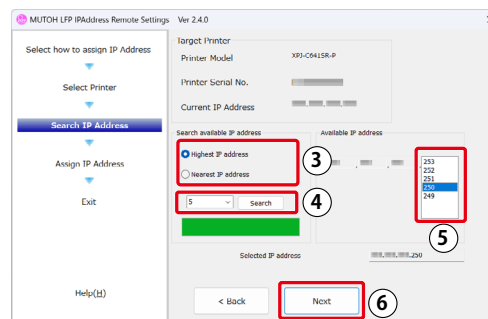

2. Find a new IP address.
  - Select the method to find (③).
  - Click [Search] (④).
  - Select an IP address from the list (⑤), and click [Next] (⑥).

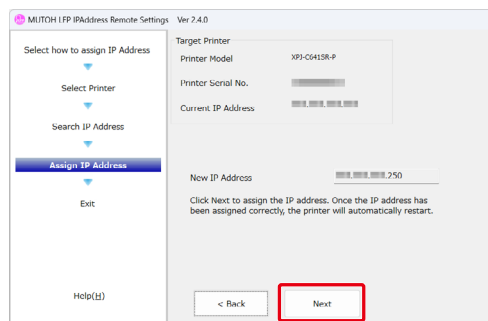

3. Click [Next].
  - Please wait until the IP address is changed.

Before Use

Printer main components / Functions

Basic Operations

Connecting to a Computer

Cutting Workflow

System configuration of this product

Maintenance

Launching/ Opening/ Exiting MSM

When problems occur

Launching VerteLith

Appendix

What you can do on this machine

Printing area

Supported media

Precautions

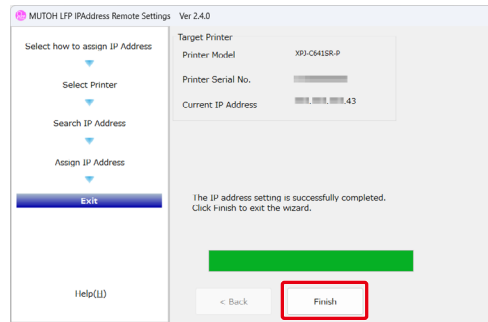

4. IP address has changed. Click [Finish] to exit MUTOH LFP Finder.
5. Once the IP address of the machine has changed, you will also need to change the IP address of the machine specified in MSM. Move to the following section.

["Changing the IP address registered in MSM" P.32](#)

## When "Specify IP Address manually" is selected

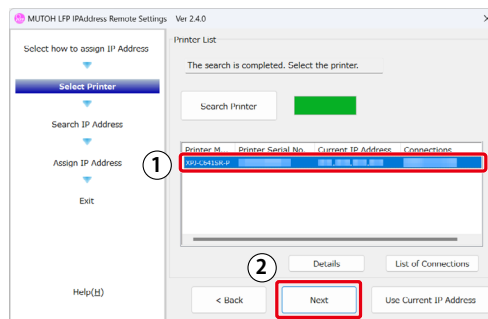

1. Select the machine you want to change the IP address (①) , and click [Next] (②) .

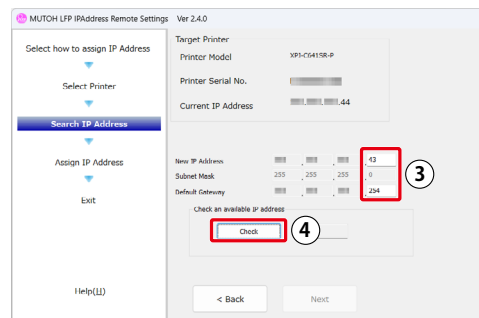

2. Enter a new IP address directly (③) . Click [Check] (④) to check if the IP Address entered can be assigned for the machine.

## Before Use

Printer main components / Functions

## Basic Operations

Connecting to a Computer

## Cutting Workflow

System configuration of this product

## Maintenance

Launching/ Opening/ Exiting MSM

## When problems occur

Launching VerteLith

## Appendix

What you can do on this machine

Printing area

Supported media

Precautions

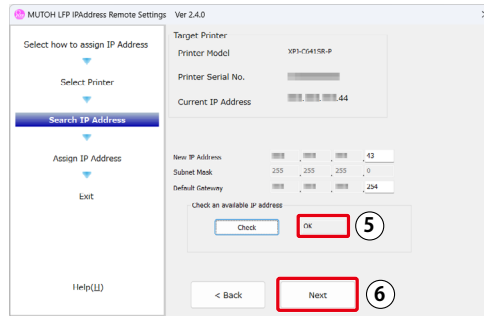

3. If "OK" appears, you can use the IP address (5) . Click [Next] (6) .
  - Please wait until the IP address is changed.

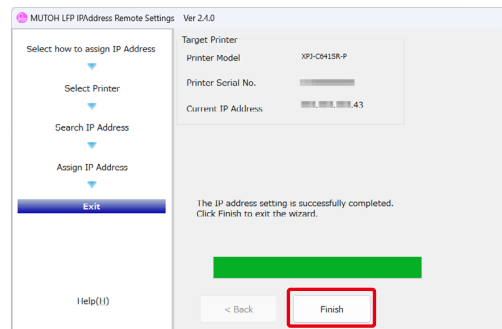

4. IP address has changed. Click [Finish] to exit MUTOH LFP Finder.
5. Once the IP address of the machine has changed, you will also need to change the IP address of the machine specified in MSM. Move to the following section.

 ["Changing the IP address registered in MSM" P.32](#)

## Changing the IP address registered in MSM

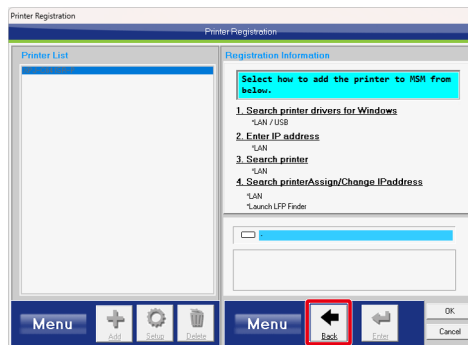

1. Click [Back].



## Before Use

Printer main components / Functions

## Basic Operations

Connecting to a Computer

## Cutting Workflow

System configuration of this product

## Maintenance

Launching/ Opening/ Exiting MSM

## When problems occur

Launching VerteLith

## Appendix

What you can do on this machine

Printing area

Supported media

Precautions

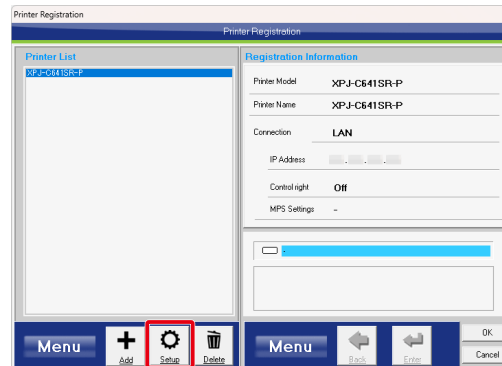

2. Click [Setup].

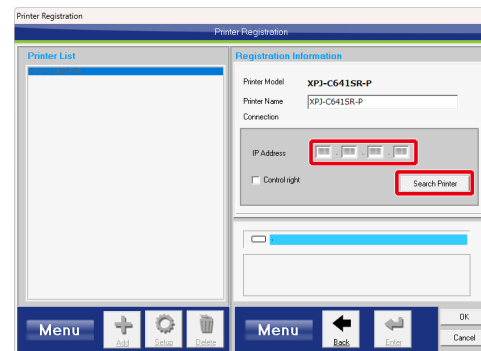

3. Search the IP address of the printer that IP address has been changed.

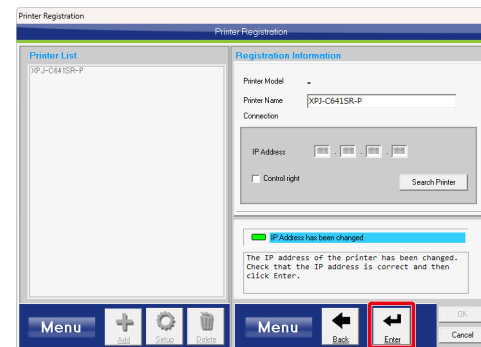

4. Click [Enter].

<b>Before Use</b>	Printer main components / Functions
<b>Basic Operations</b>	Connecting to a Computer
<b>Cutting Workflow</b>	System configuration of this product
<b>Maintenance</b>	<b>Launching/ Opening/ Exiting MSM</b>
<b>When problems occur</b>	Launching VerteLith
<b>Appendix</b>	What you can do on this machine
	Printing area
	Supported media
	Precautions

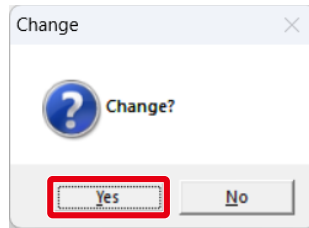

5. A confirmation dialog appears. Click [Yes].

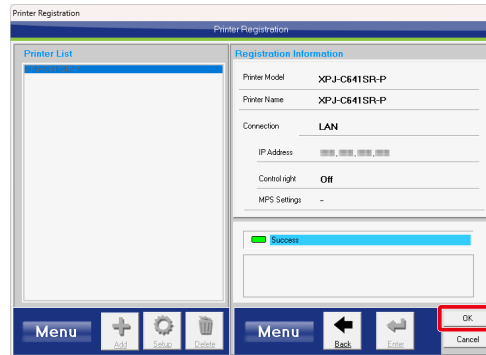

6. The IP address change is complete. Click [OK] to exit the page.

Before Use

Printer main components /  
Functions

Basic  
Operations

Connecting to a Computer

Cutting  
Workflow

System configuration of  
this product

Maintenance

Launching/ Opening/  
Exiting MSM

When problems  
occur

Launching VerteLith

Appendix

What you can do on this  
machine

Printing area

Supported media

Precautions

## Exiting MSM

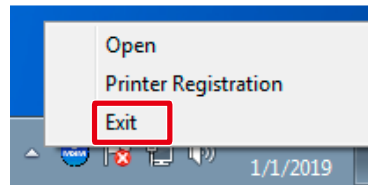

Windows 11 / Windows 10

1. Right click the MSM icon in the task tray, and click [Exit].

### Note

While using your printer, do not exit MSM. To close the MSM window, click [Settings] - [Close].

Before Use

Printer main components / Functions

Basic Operations

Connecting to a Computer

Cutting Workflow

System configuration of this product

Maintenance

Launching/ Opening/ Exiting MSM

When problems occur

Launching VerteLith

Appendix

What you can do on this machine

Printing area

Supported media

Precautions

# Launching VerteLith

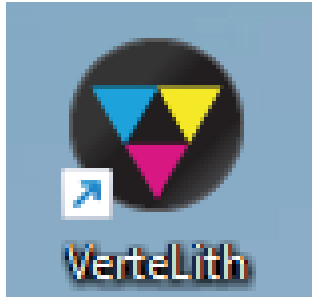

Windows 11 / Windows 10

1. Double click the VerteLith icon on the Desktop.

## Note

Launching from the Start Menu of Windows

- Windows 11 / Windows 10  
From the [Start] menu, click [All Programs] (or [All Apps]) - [MUTOH] - [VerteLith].

Before Use

Printer main components / Functions

Basic Operations

Connecting to a Computer

Cutting Workflow

System configuration of this product

Maintenance

Launching/ Opening/ Exiting MSM

When problems occur

Launching VerteLith

Appendix

What you can do on this machine







Printing area

Supported media

Precautions

# What you can do on this machine

This machine can output the following four methods.

Print only	Print a design.  <a href="#">"Printing workflow" P.44</a>
Print and Cut separately	This is used when you will remove the media after printing, laminate it or do other treatment and load it again for cutting. The crop mark is used for registration when reloading the media. You will need output data for printing and cutting.  <a href="#">"Print and cut separately" P.133</a> <div style="border: 1px solid green; padding: 5px;"> <b>Important !</b> Secure enough margin at the top and bottom of media.</div>
Print and Cut (Continuously)	Print a design and then cut it out. You will need output data for printing and cutting.  <a href="#">"Print &amp; Cut" P.142</a> <div style="border: 1px solid green; padding: 5px;"> <b>Important !</b> Cutting must be performed after the print is completely dry.</div>
Cut only	This is used for cutting out stickers. You will need output data for cutting.  <a href="#">"Cut only" P.144</a>

Before Use

Printer main components / Functions

Basic Operations

Connecting to a Computer

Cutting Workflow

System configuration of this product

Maintenance

Launching/ Opening/ Exiting MSM

When problems occur

Launching VerteLith

Appendix

What you can do on this machine

Printing area

Supported media

Precautions

# Printing area

The machine always starts printing from the Origin position (print start point). The illustration below is an example of output result.

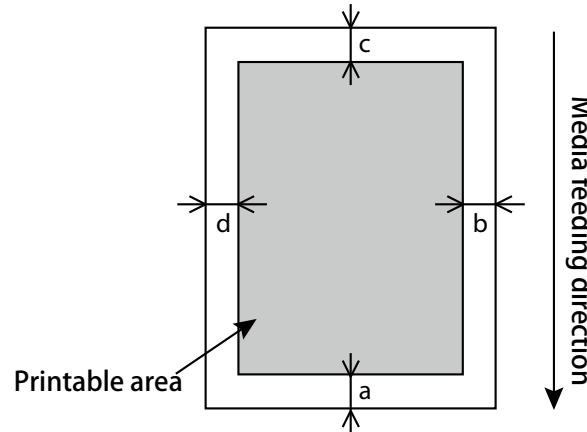

a=5mm \*1 \*2

b=15mm~25mm \*3

c=5mm

d=15mm~25mm \*3\*4

\*1 Machine leaves 15 mm margin on top after media initialization, manual backward media feeding or anti-sticking treatment.

\*2 Machine leaves 40 mm margin on top when Media Initial is set to Top or after auto cutting.

\*3 Margin can be changed from the remote panel.

\*4 More than 15 mm is required as the edge of media is held down by pressure roller

Before Use

Printer main components / Functions

Basic Operations

Connecting to a Computer

Cutting Workflow

System configuration of this product

Maintenance

Launching/ Opening/ Exiting MSM

When problems occur

Launching VerteLith

Appendix

What you can do on this machine

Printing area

Supported media

Precautions

# Supported media

Media that meet the requirements below can be used on this product.

## Media Size

Width<sup>\*1</sup>

- 198 ~ 228 mm
- 283 ~ 313 mm
- 344 ~ 374 mm
- 394 ~ 424 mm
- 444 ~ 474 mm
- 494 ~ 524 mm
- 602 ~ 630<sup>\*2</sup>mm

<sup>\*1</sup> Common to cut sheet and roll media.

<sup>\*2</sup> Maximum width (For a roll media, width of paper core or media whichever is greater).

Maximum thickness	For printing only	Head height "Low":	0.4 mm (Maximum thickness that media can pass through the media path: 0.8 mm)
		For cutting	0.4 mm (including media <sup>*3</sup> and backing material) <sup>*3</sup> Thickness of film 0.22 mm
Roll media outer diameter			up to 150 mm
Paper core diameter			2 inches or 3 inches
Weight			up to 9 kg

### Important!

The default head height is set to "Low".  
In the "Low" setting, media up to 0.4 mm thick can be loaded on the printer.

### Note

For recommended media, please contact your local MUTOH dealer.

## Before Use

Printer main components / Functions

## Basic Operations

Connecting to a Computer

## Cutting Workflow

System configuration of this product

## Maintenance

Launching/ Opening/ Exiting MSM

## When problems occur

Launching VerteLith

## Appendix

What you can do on this machine

Printing area

Supported media

Precautions

## Media handling cautions

Note the following points when handling the media.

- Use the media under an appropriate environment. The appropriate temperature and humidity for printing are as follows.

Recommended Printing Environment	Temperature: 22° C to 30° C Humidity: 40% to 60%, No condensation
----------------------------------	--

Rate of change	Temperature: within 2° C per hour Humidity: within 5% per hour
----------------	---

- Do not use folded, scratched, torn, and rolled media.
- The size of media can change according to changes in humidity in the printing environment. Before using media, rest it in the printing environment for 1 hour to adapt it to the environment. Printing without adapting media to the printing environment may cause media jams due to gaps or wrinkles in the media. Print quality is also affected.
- When using this machine in a low-humidity environment, the cut media may get stuck and may not come down. In such a case, open the front cover after the media is cut and remove it.
- Do not touch the print side. Moisture and oil on your hands may affect the print quality.
- Do not leave media loaded in the printer for a long time. Some media has winding curls, causing media jams and degradation of print quality. Avoid using such media especially in winter or in dry conditions.
- Do not discard the original packaging box and plastic bag of roll media. You will use them for storing media.

## Precaution on storing media after use

When storing roll media after use, follow these precautions to avoid print defects caused by cockling.

- After removing your roll media from the scroller, wind it back onto the roll properly and put it in the original plastic bag. Then store it in the package it came in.
- Avoid high temperature, high humidity, and direct sunlight when storing media.
- Keep the media dry.



Before Use

Printer main components /  
Functions

Basic  
Operations

Connecting to a Computer

Cutting  
Workflow

System configuration of  
this product

Maintenance

Launching/ Opening/  
Exiting MSM

When problems  
occur

Launching VerteLith

Appendix

What you can do on this  
machine

Printing area

Supported media

Precautions

# Precautions

## Please use this printer regularly

Mutoh recommends to use this printer at least once a week.

If the printer is not used for a long time, the print head could get clogged, causing damage to the printer.

## Please handle ink cartridge carefully

- Before using the ink cartridge for the first time, be sure to read the Safety Data Sheet (SDS) before carrying out any work.
- Do not disassemble the ink cartridge.  
If disassembled, the ink may get into the eyes or on the skin, causing irritation or allergic reactions.
- When handling ink cartridges, be careful not to get ink in your eyes or on your skin.  
If in eyes or on skin, immediately flush with water. If left untreated, it could result in bloodshot eyes or mild inflammation. If abnormality persists, seek medical advice immediately.
- Do not drop the ink cartridge or hit it hard. Ink may leak.
- Ink should be used up within the expiration date.  
Expired ink should be disposed of as industrial waste, and empty ink cartridges should be put in plastic bags and disposed of in accordance with local ordinances and municipal regulations.
- Use MUTOH genuine ink.  
This product is designed to get the best performance of the product by using MUTOH genuine inks. Use of non-genuine ink may adversely affect the product itself and print quality.

Before Use

Printer main components /  
Functions

Basic  
Operations

Connecting to a Computer

Cutting  
Workflow

System configuration of  
this product

Maintenance

Launching/ Opening/  
Exiting MSM

When problems  
occur

Launching VerteLith

Appendix

What you can do on this  
machine

Printing area

Supported media

Precautions

## Please conduct maintenance regularly

This product requires regular user maintenance.

- Run a nozzle check before printing. If the nozzles are clogged, run a head cleaning.
- Clean the cleaning wiper and the parts around the print head once a week.
- Clean the inside the machine once a month.

## Some parts need to be replaced periodically

In this product, the following parts must be replaced after a long-term use.

- User replaceable parts:  
Flushing box pad, Blade for sheet cutter, Blade for contour cutter, Blade holder, Cutting mat, Cleaning wiper, Plug for high-capacity ink pack adapter
- Parts required to be replaced by service personnel:  
Motors, Pumps, Print heads

# Basic Operations

Printing workflow	44
Powering ON / OFF	45
Sleep Mode	47
Loading media into the machine	51
Nozzle check and cleaning	57
Calibrating your printer	63
Start printing	78
Pause / Resume a print job	84
Cancel a print job	85
Feed/ Rewind media	87
Cut the media	89
High-Capacity ink pack adapter	93
Adjust head height	94
Advanced settings	96

Before Use

Basic Operations

Cutting Workflow

Maintenance

When problems occur

Appendix

## Printing workflow

Powering ON / OFF

Sleep Mode

Loading media into the machine

Nozzle check and cleaning

Calibrating your printer

Start printing

Pause / Resume a print job

Cancel a print job

Feed/ Rewind media

Cut the media

High-Capacity ink pack adapter

Adjust head height

Advanced settings

# Printing workflow

The following is the basic operation flow for printing.

## 1. Turn on the machine.

☞ "Turning the power ON" P.45

## 2. Load media into the machine.

☞ "Loading media into the machine" P.51

## 3. Run a nozzle check (perform cleaning if needed).

☞ "Nozzle check and cleaning" P.57

## 4. Perform printing quality calibrations(if needed).

☞ "Calibrating your printer" P.63

## 5. Print a design.

- We will introduce the printing procedure using MUTOH RIP software "VerteLith".

☞ "Start printing" P.78

## 6. End the printing operation.

Before Use

Printing workflow

Basic Operations

Powering ON / OFF

Cutting Workflow

Sleep Mode

Maintenance

Loading media into the machine

When problems occur

Nozzle check and cleaning

Appendix

Calibrating your printer

Start printing

Pause / Resume a print job

Cancel a print job

Feed/ Rewind media

Cut the media

High-Capacity ink pack adapter

Adjust head height

Advanced settings

# Powering ON / OFF

## Turning the power ON

- 1 Close the front cover.
- 2 Press the power button on this machine.
  - The blue lamp on the panel lights up.
  - Machine initialization begins.

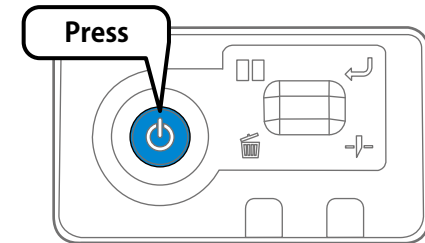

Before Use

Printing workflow

Basic Operations

Powering ON / OFF

Cutting Workflow

Sleep Mode

Maintenance

Loading media into the machine

When problems occur

Nozzle check and cleaning

Appendix

Calibrating your printer

Start printing

Pause / Resume a print job

Cancel a print job

Feed/ Rewind media

Cut the media

High-Capacity ink pack adapter

Adjust head height

Advanced settings

## Turning the power OFF

- 1 Check that printing has finished.
- 2 Press the power button on this machine.

- The blue lamp on the panel turns off.
- The machine begins powering off.

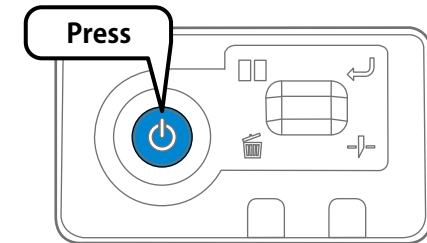

- 3 Turn the media fixing handle to unlock it.

### Important!!

- If the media fixing handle remains locked, the error LED turns on and you cannot turn off the machine. Make sure to unlock it.
- When you are not using the machine while it is powered on, unlock the media fixing handle.

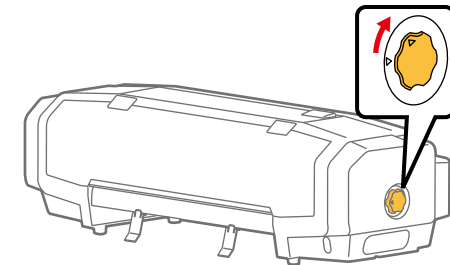

Before Use

Basic Operations

Cutting Workflow

Maintenance

When problems occur

Appendix

Printing workflow

Powering ON / OFF

Sleep Mode

Loading media into the machine

Nozzle check and cleaning

Calibrating your printer

Start printing

Pause / Resume a print job

Cancel a print job

Feed/ Rewind media

Cut the media

High-Capacity ink pack adapter

Adjust head height

Advanced settings

# Sleep Mode

While in sleep mode, the machine performs following automatically:

- power saving
- scheduled automatic head cleaning

## Important!

If you are going to put the machine in sleep mode for more than 7 days, perform followings once a week:

- Check the ink level in the ink cartridges. When the message [Ink Low] appears on the control panel, replace with new ones.
- Run a nozzle check. If nozzle clogs, perform head cleaning.

## To start and end sleep mode

### 1. Putting the machine into sleep mode

#### 1 Check that

- the front cover is closed.
- ink cartridges have sufficient ink.
- the waste ink tank has enough space.
- the media fixing handle is unlocked.

## Important!!

If you are going to leave the printer in sleep mode for a long period of time, empty the waste ink tank.

#### 2 Start MSM and open the remote panel.

 ["Displaying remote panel" P.27](#)

Before Use

Printing workflow

Basic Operations

Powering ON / OFF

Cutting Workflow

Sleep Mode

Maintenance

Loading media into the machine

When problems occur

Nozzle check and cleaning

Appendix

Calibrating your printer

Start printing

Pause / Resume a print job

Cancel a print job

Feed/ Rewind media

Cut the media

High-Capacity ink pack adapter

Adjust head height

Advanced settings

**3** In the Sleep Mode option, click [Start].

- A confirmation message appears.

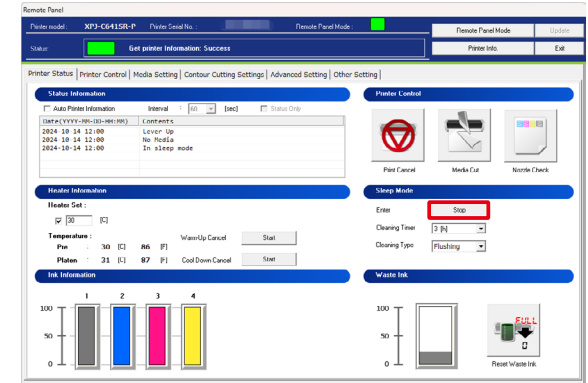

**4** Click [Yes].

- The machine is put into sleep mode.

**Note**

Data LED blinks while in sleep mode.

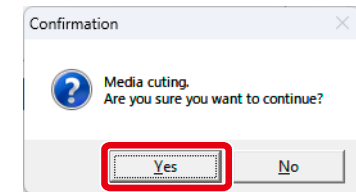

**Important!!**

If the media fixing handle remains locked, the error LED turns on and you cannot put the machine into sleep mode. Make sure to unlock it.



Before Use

Printing workflow

Basic Operations

Powering ON / OFF

Cutting Workflow

Sleep Mode

Maintenance

Loading media into the machine

When problems occur

Nozzle check and cleaning

Appendix

Calibrating your printer

Start printing

Pause / Resume a print job

Cancel a print job

Feed/ Rewind media

Cut the media

High-Capacity ink pack adapter

Adjust head height

Advanced settings

## 2. Waking from sleep mode

**1** To wake up from sleep mode, click [Stop] in the Sleep Mode option.

- A confirmation message appears.

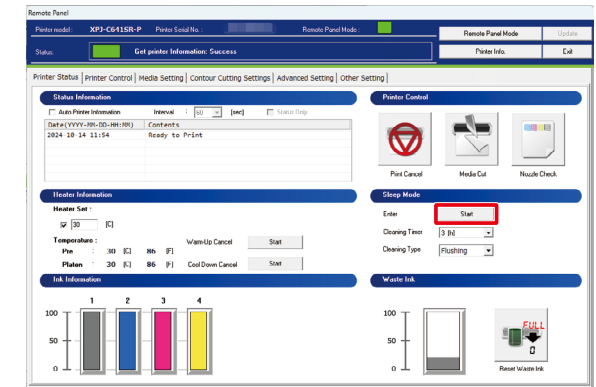

**2** Click [Yes].

- The machine is woke up from sleep mode.

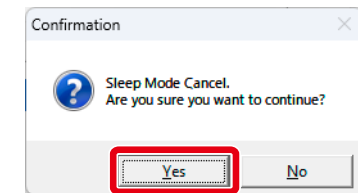

### Note

Depending on the elapsed time, this product may perform automatic head cleaning or ink charging when waking from sleep mode. This is due to automatic maintenance function, not the sleep mode settings.

Before Use

Printing workflow

Basic Operations

Powering ON / OFF

Cutting Workflow

Sleep Mode

Maintenance

Loading media into the machine

When problems occur

Nozzle check and cleaning

Appendix

Calibrating your printer

Start printing

Pause / Resume a print job

Cancel a print job

Feed/ Rewind media

Cut the media

High-Capacity ink pack adapter

Adjust head height

Advanced settings

### 3. Setting a timer for automatic head cleaning

You can set a timer for automatic head cleaning to be performed during sleep mode.

- 1 To change the timer for cleaning during sleep mode, select time interval from the Cleaning Timer option in the Sleep Mode menu.

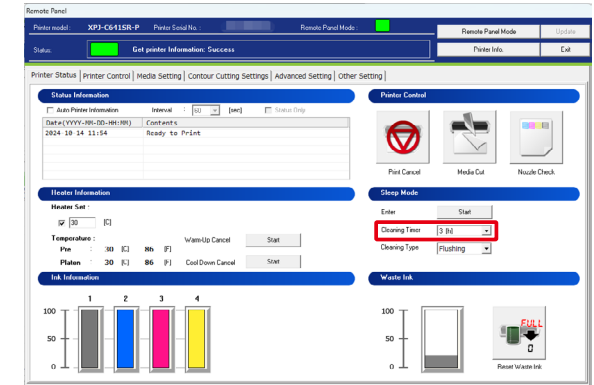

- 2 Click [Update].

- Timer has set.

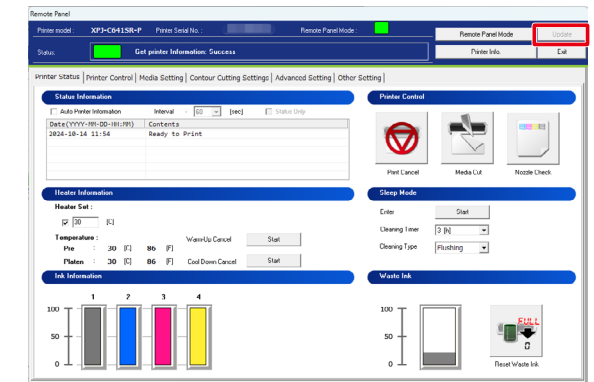

#### Note

Cleaning mode for head cleaning can be changed from the Cleaning Mode option in the Advanced Setting tab.

Before Use

Printing workflow

Basic Operations

Powering ON / OFF

Cutting Workflow

Sleep Mode

Maintenance

Loading media into the machine

When problems occur

Nozzle check and cleaning

Appendix

Calibrating your printer

Start printing

Pause / Resume a print job

Cancel a print job

Feed/ Rewind media

Cut the media

High-Capacity ink pack adapter

Adjust head height

Advanced settings

# Loading media into the machine

Follow these steps.

## Loading a roll media into the printer

### 1. Loading a roll media onto the spindle

Items Required:

- Roll media: x1
- Scroller: x1

1 Remove the 3-inch adapters and the media stopper (movable) from the scroller.

#### Note

If you are using a roll media with 3-inch paper core, leave the 3-inch adapters attached.

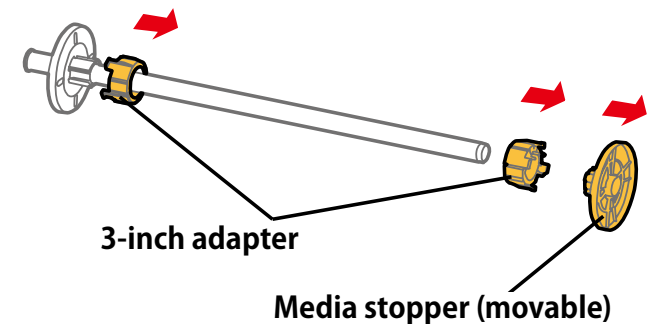

## Before Use

Printing workflow

## Basic Operations

Powering ON / OFF

## Cutting Workflow

Sleep Mode

## Maintenance

Loading media into the machine

## When problems occur

Nozzle check and cleaning

Calibrating your printer

## Appendix

Start printing

Pause / Resume a print job

Cancel a print job

Feed/ Rewind media

Cut the media

High-Capacity ink pack adapter

Adjust head height

Advanced settings

**2** Load the roll media onto the scroller.

### Note

Load the roll media so that the winding direction of media is as shown in the illustration.

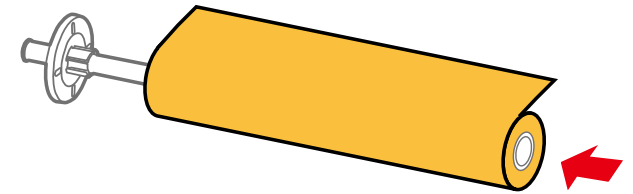

**3** Push the media stopper tightly into the roll media until there is no gap between the media and the stopper.

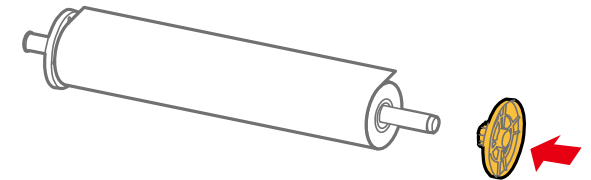

## 2. Placing the roll media onto the scroller holder

**1** Place the scroller onto the media holder.

### Note

Place it so that the media stopper (movable) is on the right side when looking from the rear side of the machine.

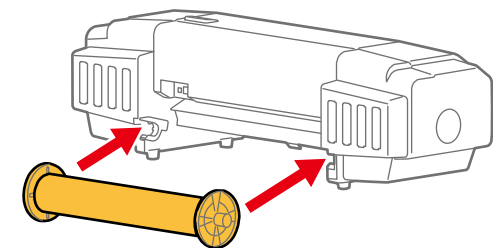

Before Use

Basic Operations

Cutting Workflow

Maintenance

When problems occur

Appendix

Printing workflow

Powering ON / OFF

Sleep Mode

Loading media into the machine

Nozzle check and cleaning

Calibrating your printer

Start printing

Pause / Resume a print job

Cancel a print job

Feed/ Rewind media

Cut the media

High-Capacity ink pack adapter

Adjust head height

Advanced settings

### 3. Loading the media into the machine

1 Turn the media fixing handle to unlock it.

- The pinch rollers raise.

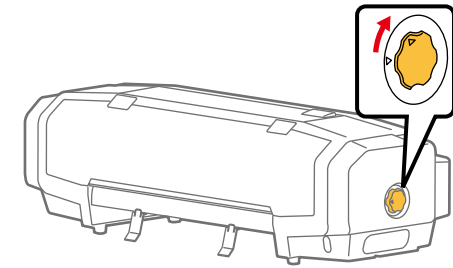

2 Insert the leading edge of roll media into the media slot.

#### Important!

When loading a cut sheet, remove the scroller and roll media from the machine first and then load the sheet.

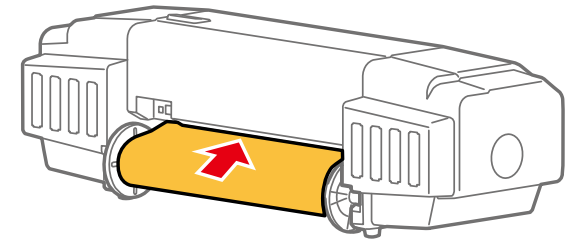
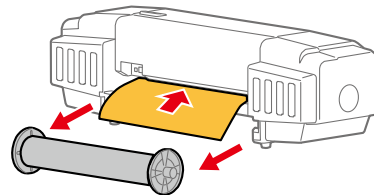

3

- Open the front cover.
- From the front side of the machine, pull the media.

#### Note

Remove warp on the media.  
For roll media, turn the scroller to slightly rewind the media onto the roll.

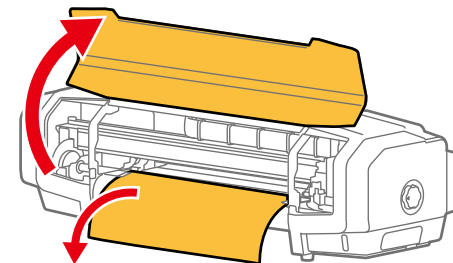

Before Use

Printing workflow

Basic Operations

Powering ON / OFF

Cutting Workflow

Sleep Mode

Maintenance

Loading media into the machine

When problems occur

Nozzle check and cleaning

Appendix

Calibrating your printer

Start printing

Pause / Resume a print job

Cancel a print job

Feed/ Rewind media

Cut the media

High-Capacity ink pack adapter

Adjust head height

Advanced settings

4

Move the pinch roller arms to the both end of media.

- Make sure to check that the pinch roller arms are raised (in UP position).
- Hold the base of the arm and slowly move it. If the movement is heavy, move the arm while holding the printer.

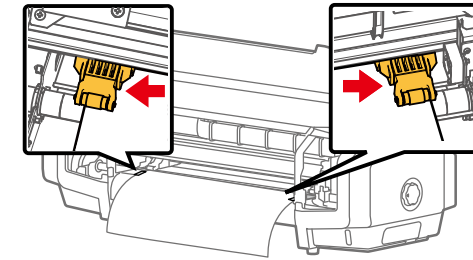
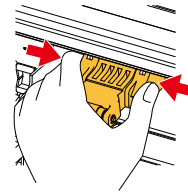

Important!

Check that the pinch rollers and media are positioned as shown in the illustration.

- The pinch roller and media are on the protruding part of the grit roller.

(The black labels on the Y rail indicate the position of protruding part of the grit roller. Please use this as a guide when checking.)

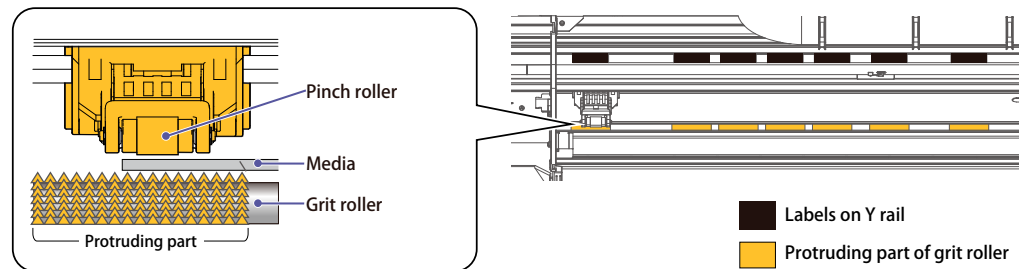

- The edge of media and the edge of pinch roller are aligned.

Good

No Good

No Good

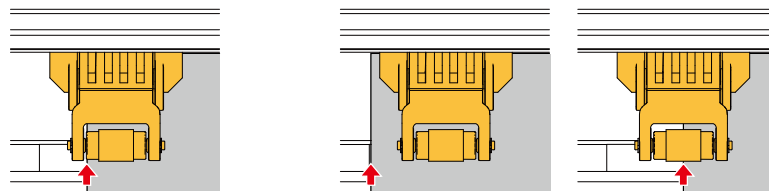

Before Use

Printing workflow

Basic Operations

Powering ON / OFF

Cutting Workflow

Sleep Mode

Maintenance

Loading media into the machine

When problems occur

Nozzle check and cleaning

Appendix

Calibrating your printer

Start printing

Pause / Resume a print job

Cancel a print job

Feed/ Rewind media

Cut the media

High-Capacity ink pack adapter

Adjust head height

Advanced settings

**5** Turn the media fixing handle to lock it.

- The pinch rollers lower.

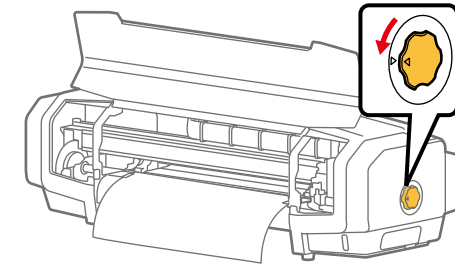

**6** Place the edge holders on both ends of the media.

- Slide them from both sides and place on the ends of the media.

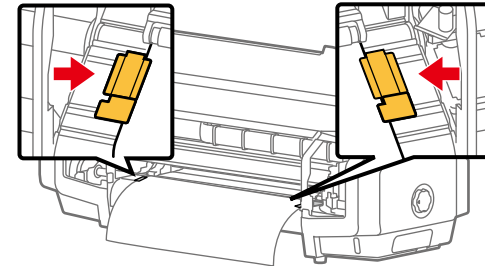

**7** Close the front cover.

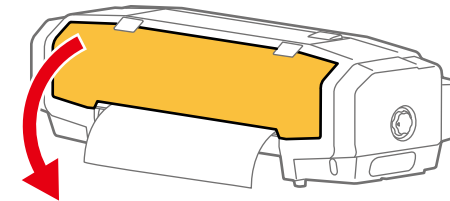

Before Use

Printing workflow

Basic Operations

Powering ON / OFF

Cutting Workflow

Sleep Mode

Maintenance

Loading media into the machine

When problems occur

Nozzle check and cleaning

Appendix

Calibrating your printer

Start printing

Pause / Resume a print job

Cancel a print job

Feed/ Rewind media

Cut the media

High-Capacity ink pack adapter

Adjust head height

Advanced settings

## Loading a cut sheet into the machine

For how to load a cut sheet, follow the same procedure as "Loading the media into the machine".

 ["3. Loading the media into the machine" P.53](#)

To load a cut sheet that has crop marks, you will need to adjust the position.

 ["Step2. Cut" P.140](#)

### Important!

For the required cut sheet size and margins for an image with crop marks, see the following section.

 ["Required media size for automatic detection of crop marks" P.133](#)



Before Use

Printing workflow

Basic Operations

Powering ON / OFF

Cutting Workflow

Sleep Mode

Maintenance

Loading media into the machine

When problems occur

Nozzle check and cleaning

Calibrating your printer

Appendix

Start printing

Pause / Resume a print job

Cancel a print job

Feed/ Rewind media

Cut the media

High-Capacity ink pack adapter

Adjust head height

Advanced settings

# Nozzle check and cleaning

## Run a nozzle check

Before you start daily operation, run a nozzle check. If nozzles are clogged, perform cleaning.

This machine offers the following nozzle check menus:

- Nozzle Check: Prints a nozzle check pattern using the settings specified in the Nozzle Area Select option in the Advanced Setting tab.

👉 ["Nozzle check steps" P.59](#)

- Nozzle Check F: Prints a nozzle check pattern using all nozzles.

👉 ["Nozzle check F steps" P.57](#)

## Nozzle check F steps

- 1 Load media to print a nozzle check pattern.  
👉 ["Loading media into the machine" P.51](#)

- 2 Start MSM and open the remote panel.  
👉 ["Launching/ Opening/Exiting MSM" P.26](#)

- 3 Click the Printer Control tab.
  - The Printer Control tab page opens.

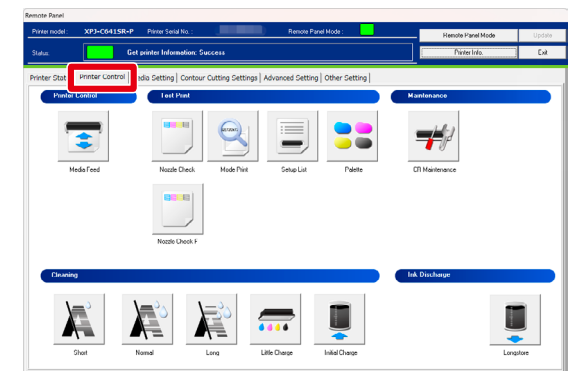

## Before Use

Printing workflow

## Basic Operations

Powering ON / OFF

## Cutting Workflow

Sleep Mode

## Maintenance

Loading media into the machine

## When problems occur

Nozzle check and cleaning

## Appendix

Calibrating your printer

Start printing

Pause / Resume a print job

Cancel a print job

Feed/ Rewind media

Cut the media

High-Capacity ink pack adapter

Adjust head height

Advanced settings

4

Click [Nozzle Check F] in the Test Print menu.

- The machine begins printing a nozzle check pattern.

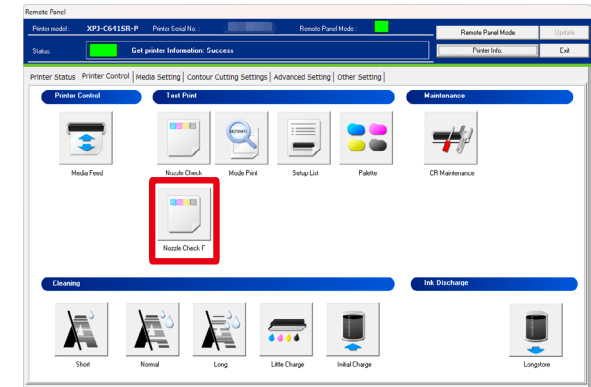

5

Check the nozzle check print.

- If you see nozzle clogging (missing line) or thin lines on the print, go to **"Head cleaning" P.61**.
- If all lines are clearly printed, you can start printing.

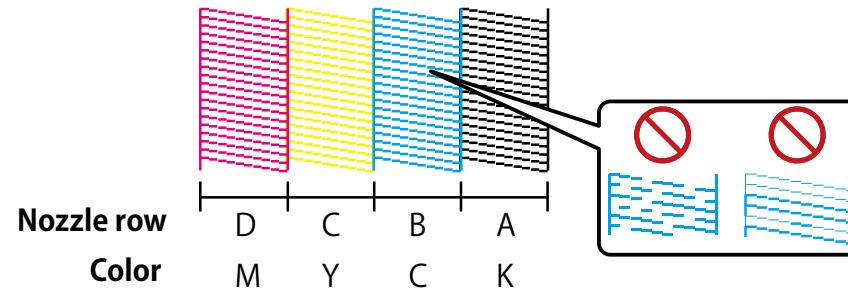

### Note

Printer information (date and time printed, serial number, firmware version) is printed next to the pattern.

Before Use

Printing workflow

Basic Operations

Powering ON / OFF

Cutting Workflow

Sleep Mode

Maintenance

Loading media into the machine

When problems occur

Nozzle check and cleaning

Appendix

Calibrating your printer

Start printing

Pause / Resume a print job

Cancel a print job

Feed/ Rewind media

Cut the media

High-Capacity ink pack adapter

Adjust head height

Advanced settings

## Nozzle check steps

1 Load media to print a nozzle check pattern.  
👉 "Loading media into the machine" P.51

2 Start MSM and open the remote panel.  
👉 "Launching/ Opening/Exiting MSM" P.26

3 Click the Printer Control tab.  
• The Printer Control tab page opens.

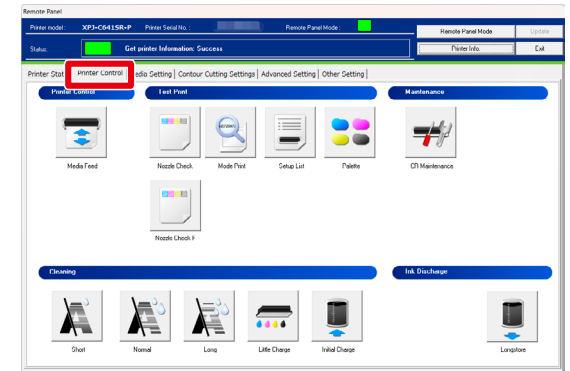

4 Click [Nozzle Check] in the Test Print menu.  
• The machine begins printing a nozzle check pattern.

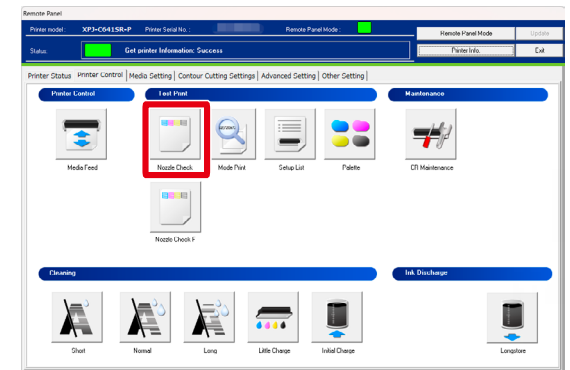

## Before Use

Printing workflow

## Basic Operations

Powering ON / OFF

## Cutting Workflow

Sleep Mode

## Maintenance

Loading media into the machine

## When problems occur

**Nozzle check and cleaning**

Calibrating your printer

## Appendix

Start printing

Pause / Resume a print job

Cancel a print job

Feed/ Rewind media

Cut the media

High-Capacity ink pack adapter

Adjust head height

Advanced settings

### 5 Check the nozzle check print.

- If you find missing or thin lines on the print, go to "Head cleaning" P.61 .
- If all lines are clearly printed, you can start printing.

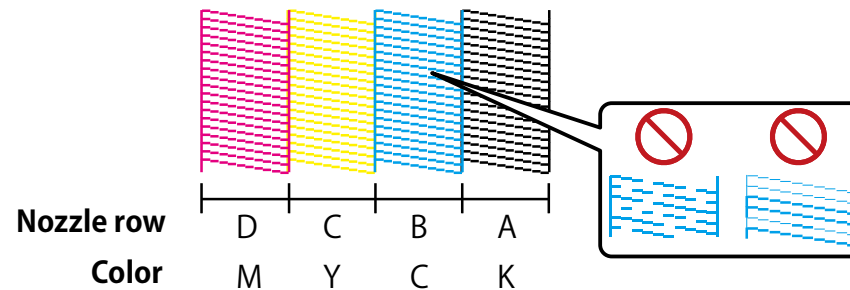

#### Note

- The above illustration is an example of pattern with Nozzle Area Select set to "Nozzle ALL".
- Use MSM to set the Nozzle Area Select option.
- Printer information (date and time printed, serial number, firmware version, Nozzle Area Select setting) is printed next to the pattern.

#### Important!

If you run a nozzle check print immediately after initial ink charging is complete, the following symptom may appear.

- Lines are blurred
- Image is partially not printed

In such cases, perform the "Little Charge" cleaning from [Printer Control] - [Cleaning] in MSM. Then print and check the result. If there is no improvement, leave the printer for at least one hour and then perform a head cleaning or "Little Charge" cleaning. Once finished, print an image again.

If the problem still persists, please contact your local MUTOH dealer.

Before Use

Printing workflow

Basic Operations

Powering ON / OFF

Cutting Workflow

Sleep Mode

Maintenance

Loading media into the machine

When problems occur

Nozzle check and cleaning

Appendix

Calibrating your printer

Start printing

Pause / Resume a print job

Cancel a print job

Feed/ Rewind media

Cut the media

High-Capacity ink pack adapter

Adjust head height

Advanced settings

## Head cleaning

- 1 Start MSM and open the remote panel.  
👉 "Launching/ Opening/Exiting MSM" P.26

- 2 Click the Printer Control tab.
  - The Printer Control tab page opens.

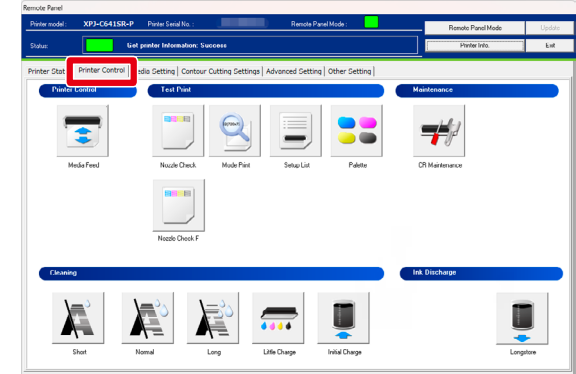

- 3 From the Cleaning menu, click [Normal].
  - Head cleaning begins.

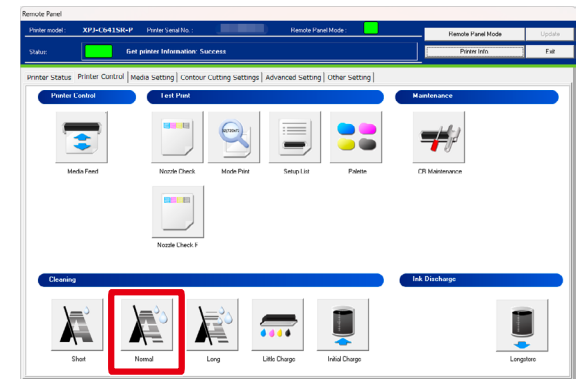

Before Use

Printing workflow

Basic Operations

Powering ON / OFF

Cutting Workflow

Sleep Mode

Maintenance

Loading media into the machine

When problems occur

Nozzle check and cleaning

Appendix

Calibrating your printer

Start printing

Pause / Resume a print job

Cancel a print job

Feed/ Rewind media

Cut the media

High-Capacity ink pack adapter

Adjust head height

Advanced settings

**4** Run a nozzle check print again.  
👉 "Run a nozzle check" P.57

- If nozzle clogging persists, repeat the Normal cleaning.
- For "Short", "Long", "Little Charge" and "Initial Charge" cleanings, see "Head Cleaning" p147.

**Note**

If nozzle clogs after "Long" or "Little Charge" cleaning attempt, you can select the nozzles that do not suffer from clogging from the Nozzle Area Select menu in the Advance Setting tab in MSM to continue printing.

Before Use

Printing workflow

Basic Operations

Powering ON / OFF

Cutting Workflow

Sleep Mode

Maintenance

Loading media into the machine

When problems occur

Nozzle check and cleaning

Appendix

Calibrating your printer

Start printing

Pause / Resume a print job

Cancel a print job

Feed/ Rewind media

Cut the media

High-Capacity ink pack adapter

Adjust head height

Advanced settings

# Calibrating your printer

The print quality calibration must be performed before you print for the first time.

## Print quality calibration ("Adjust Print")

Make sure to run this calibration when

- you use this product for the first time
- you change to the different types of media

Calibration is not required in cases other than those listed above. Move to ["Nozzle check and cleaning" P.57](#) .

This calibration adjusts dot placement position in bidirectional printing. "Adjust Print" has following menus:

Auto	The color sensor reads the adjustment pattern print and the printer runs automatic calibration.
Custom	Print an adjustment pattern and enter the number of the pattern that looks most aligned. This menu calibrates the dot placement position for all print modes. Print quality can be optimized even if the print mode selected in the RIP software and the printer are different.

### Note

To print an adjustment pattern, more than 550 mm of printable area is required. If less than 550 mm, calibration cannot be performed.

### ● Adjustment pattern for each print mode

print mode	pattern
Super Quality	Pattern F
High Quality	
Production	
High Speed	Pattern D

Before Use

Printing workflow

Basic Operations

Powering ON / OFF

Cutting Workflow

Sleep Mode

Maintenance

Loading media into the machine

When problems occur

Nozzle check and cleaning

Appendix

Calibrating your printer

Start printing

Pause / Resume a print job

Cancel a print job

Feed/ Rewind media

Cut the media

High-Capacity ink pack adapter

Adjust head height

Advanced settings

## Print quality (Adjust Print) calibration steps

### For Auto calibration

- 1 Load a roll media.  
☞ "Loading media into the machine" P.51
- 2 Start MSM and open the remote panel.  
☞ "Launching/ Opening/Exiting MSM" P.26
- 3 Go to the Media Setting tab > Adjust > Adjust Print (Auto) and click [Start].

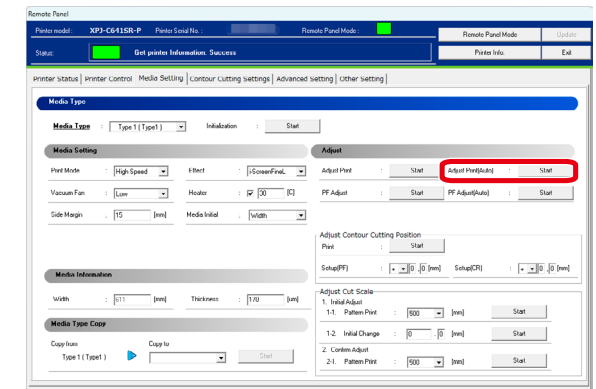

- 4 Enter the thickness of media.

- Enter the thickness of media [μm] loaded.

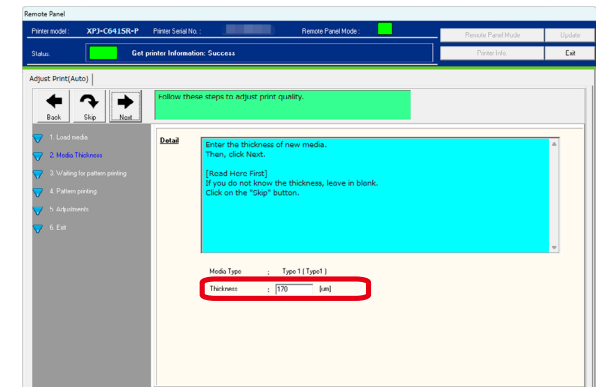



## Before Use

Printing workflow

## Basic Operations

Powering ON / OFF

## Cutting Workflow

Sleep Mode

## Maintenance

Loading media into the machine

## When problems occur

Nozzle check and cleaning

## Appendix

Calibrating your printer

Start printing

Pause / Resume a print job

Cancel a print job

Feed/ Rewind media

Cut the media

High-Capacity ink pack adapter

Adjust head height

Advanced settings

## 5 Click [Next].

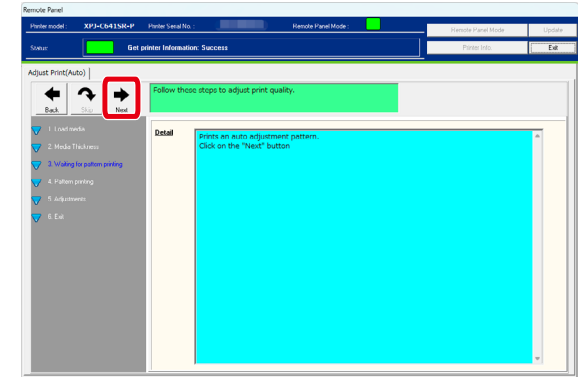

## 6 The machine begins printing a pattern.

- The color sensor reads the adjustment pattern print and the machine runs automatic calibration.

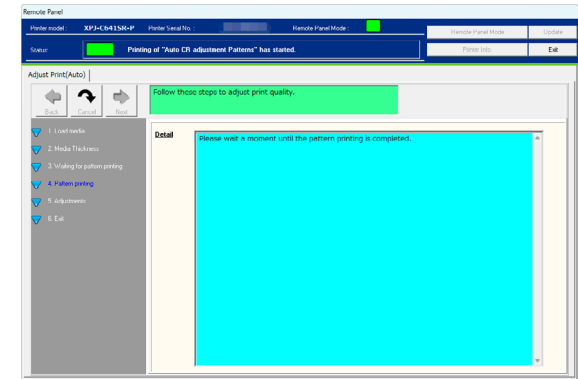

### Note

- If failed in the middle of the calibration, the adjustment value for the pattern which has been successfully calibrated will be saved in the printer, but the adjustment value for the pattern which has failed to calibrate or has not been calibrated yet will not be saved in the printer.
- If performing the auto calibration does not improve print quality (banding or graininess appears), run an [Auto] calibration again or perform [Custom] calibration.

["For Custom calibration" P.66](#)

Before Use

Basic Operations

Cutting Workflow

Maintenance

When problems occur

Appendix

Printing workflow

Powering ON / OFF

Sleep Mode

Loading media into the machine

Nozzle check and cleaning

Calibrating your printer

Start printing

Pause / Resume a print job

Cancel a print job

Feed/ Rewind media

Cut the media

High-Capacity ink pack adapter

Adjust head height

Advanced settings

## For Custom calibration

### 1. Check print quality

- 1 Go to the Media Setting tab > Adjust > Adjust Print and click [Start].

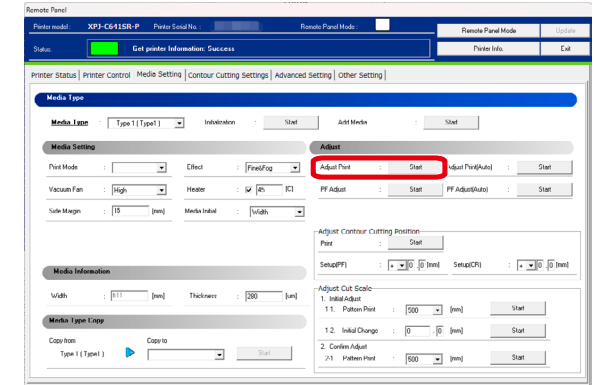

- 2 In [1. Media Thickness], enter the thickness of media.

- Enter the thickness of media ( $\mu\text{m}$ ) loaded and click [Set].

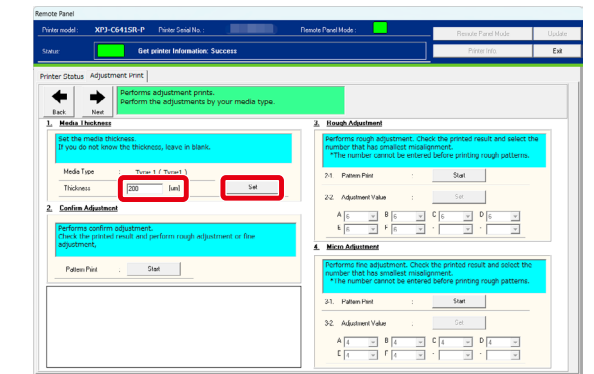

Before Use

Printing workflow

Basic Operations

Powering ON / OFF

Cutting Workflow

Sleep Mode

Maintenance

Loading media into the machine

When problems occur

Nozzle check and cleaning

Appendix

Calibrating your printer

Start printing

Pause / Resume a print job

Cancel a print job

Feed/ Rewind media

Cut the media

High-Capacity ink pack adapter

Adjust head height

Advanced settings

3 In [2. Confirm Adjustment], click [Start].

- The machine begins printing a pattern.

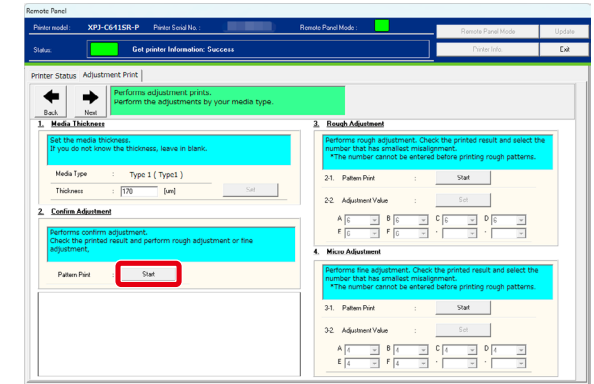

4 Look at the results of pattern A to pattern F. If there is any misalignment, move to "2. Print quality rough adjustment" P.68 .

- In the example of illustration below, the pattern A has misalignment.

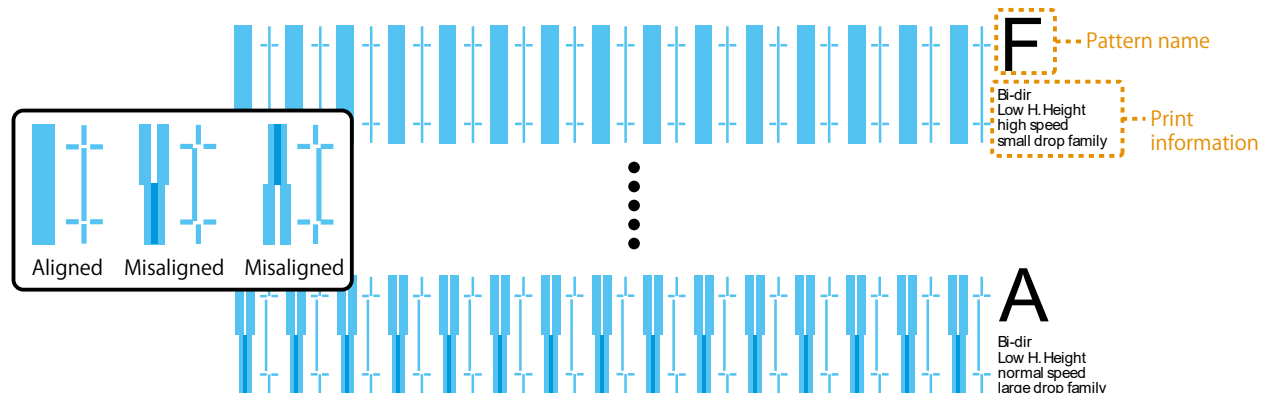

Note

The color of the rough adjustment and micro adjustment patterns is the same as this one.

Before Use

Printing workflow

Basic Operations

Powering ON / OFF

Cutting Workflow

Sleep Mode

Maintenance

Loading media into the machine

When problems occur

Nozzle check and cleaning

Appendix

Calibrating your printer

Start printing

Pause / Resume a print job

Cancel a print job

Feed/ Rewind media

Cut the media

High-Capacity ink pack adapter

Adjust head height

Advanced settings

## 2. Print quality rough adjustment

1 In [3. Rough Adjustment], click [Start] from [3-1 Pattern Print].

- The machine begins printing a pattern.

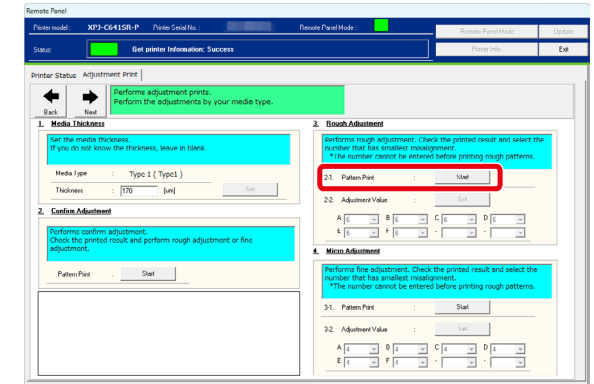

2 Find and mark the number written under the pattern that has the least misalignment in the pattern A.

- The same patterns (A to F) are printed on both sides and the center of the media.

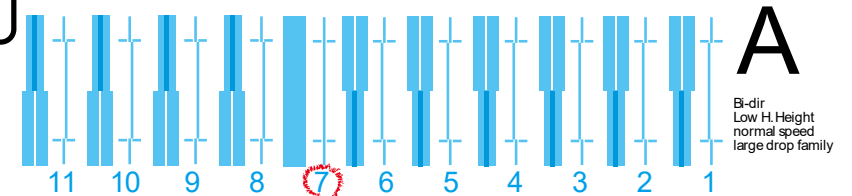
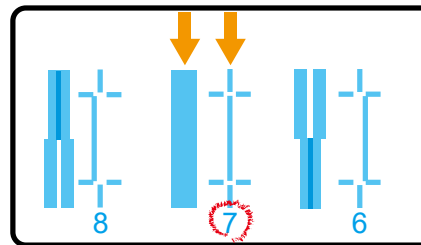

### Note

The number that has the least misalignment may be different between the edge of media and the center of media even if it has the same pattern name. In such case, look for the number that seems to have the least misalignment on average.

Before Use

Printing workflow

Basic Operations

Powering ON / OFF

Cutting Workflow

Sleep Mode

Maintenance

Loading media into the machine

When problems occur

Nozzle check and cleaning

Appendix

Calibrating your printer

Start printing

Pause / Resume a print job

Cancel a print job

Feed/ Rewind media

Cut the media

High-Capacity ink pack adapter

Adjust head height

Advanced settings

3 Mark the numbers for patterns B to F in the same way.

4 In [3-2 Adjustment Value], enter the number you marked for the patterns A to F and then click [Set].

- Move to "3. Print quality micro adjustment" P.69

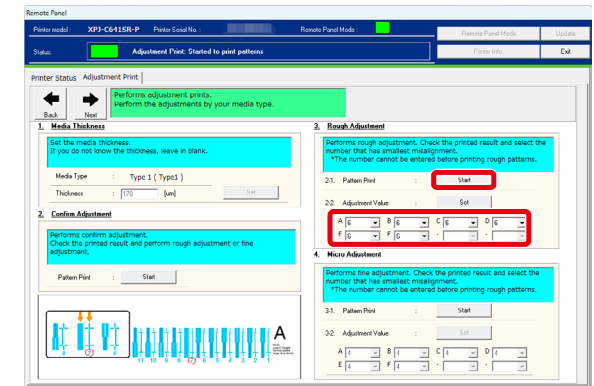

### 3. Print quality micro adjustment

1 In [4. Micro Adjustment], click [Start] from [4-1 Pattern Print].

- The machine prints the patterns A to F.

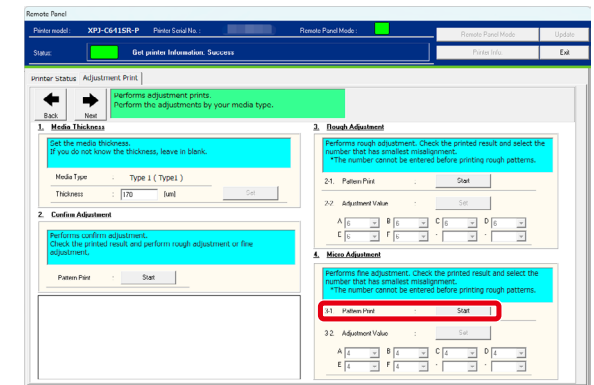

Before Use

Printing workflow

Basic Operations

Powering ON / OFF

Cutting Workflow

Sleep Mode

Maintenance

Loading media into the machine

When problems occur

Nozzle check and cleaning

Appendix

Calibrating your printer

Start printing

Pause / Resume a print job

Cancel a print job

Feed/ Rewind media

Cut the media

High-Capacity ink pack adapter

Adjust head height

Advanced settings

2

Find and mark the number written under the pattern that has the least misalignment in each pattern like you did in [3. Rough Adjustment].

- Do this for patterns A to F.

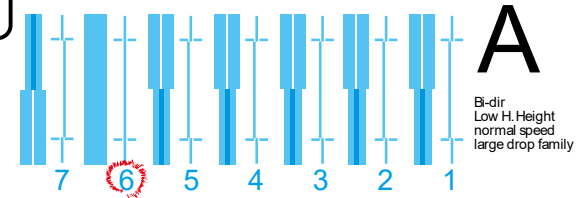
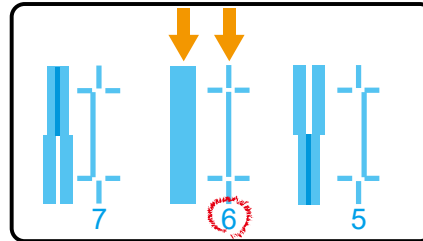

3

In [4-2 Adjustment value], enter the number you marked for patterns A to F and then click [Set].

- The print quality calibration is now completed.

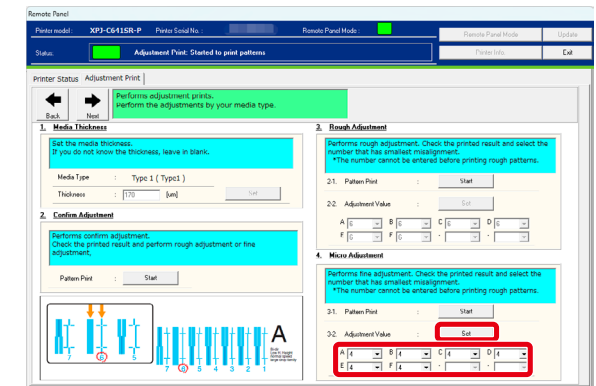

Before Use

Basic Operations

Cutting Workflow

Maintenance

When problems occur

Appendix

Printing workflow

Powering ON / OFF

Sleep Mode

Loading media into the machine

Nozzle check and cleaning

Calibrating your printer

Start printing

Pause / Resume a print job

Cancel a print job

Feed/ Rewind media

Cut the media

High-Capacity ink pack adapter

Adjust head height

Advanced settings

## Media Feed Adjustment

This adjustment corrects the media feed amount.

Make sure to run this adjustment when

- you use this product for the first time
- you changed to the different types of media

When the following symptom appears on your prints, you should run this adjustment:



- Images are overlapping.
- White lines appear in an image.

Other than above case, there is no need to perform this adjustment. Move to ["Nozzle check and cleaning" P.57](#). You will need a ruler for this adjustment.

### Media feed adjustment steps

#### Note

To print an adjustment pattern, more than 400 mm of printable area is required. If less than 400 mm, calibration cannot be performed.

- 1 Load a roll media.  
 ["Loading media into the machine" P.51](#)
- 2 Start MSM and open the remote panel.  
 ["Launching/ Opening/Exiting MSM" P.26](#)

## Before Use

Printing workflow

## Basic Operations

Powering ON / OFF

## Cutting Workflow

Sleep Mode

## Maintenance

Loading media into the machine

## When problems occur

Nozzle check and cleaning

## Appendix

Calibrating your printer

Start printing

Pause / Resume a print job

Cancel a print job

Feed/ Rewind media

Cut the media

High-Capacity ink pack adapter

Adjust head height

Advanced settings

3

Go to the Media Setting tab > Adjust > PF Adjust (Auto) and click [Start].

- The PF Adjust page opens.

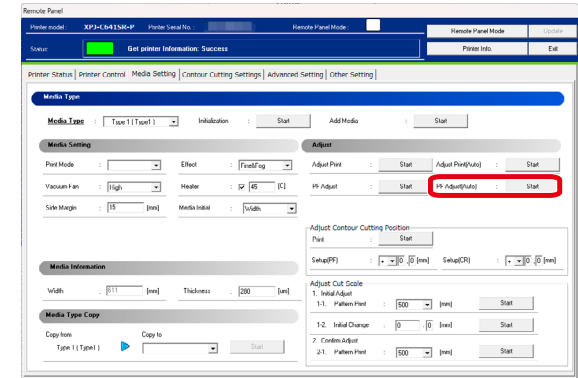

4

Click [Next].

- The machine automatically performs media feed adjustment.

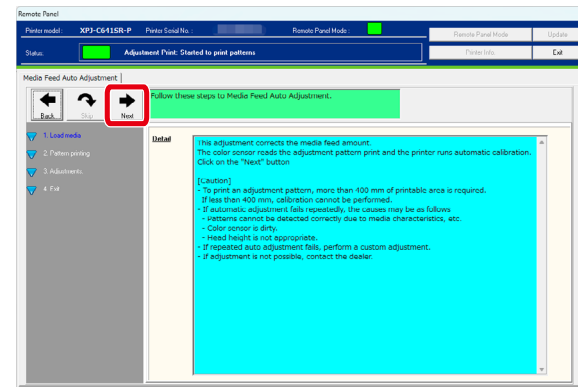

5

The media feed adjustment is now completed.

- If print defects persist after automatic media feed adjustment, perform media feed adjustment manually by checking print results.

👉 "Run a media feed adjustment manually by checking print results" P.73

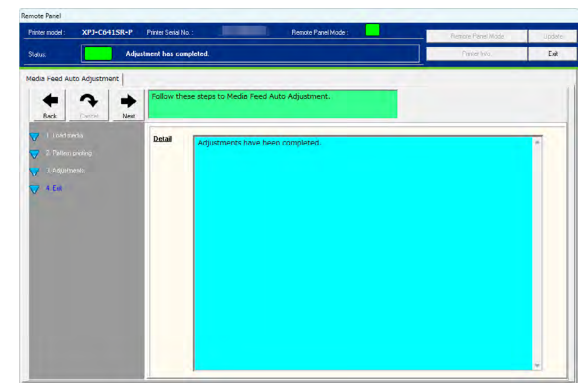



Before Use

Printing workflow

Basic Operations

Powering ON / OFF

Cutting Workflow

Sleep Mode

Maintenance

Loading media into the machine

When problems occur

Nozzle check and cleaning

Appendix

Calibrating your printer

Start printing

Pause / Resume a print job

Cancel a print job

Feed/ Rewind media

Cut the media

High-Capacity ink pack adapter

Adjust head height

Advanced settings

## Run a media feed adjustment manually by checking print results

### 1. Initial Print

- 1 Start MSM and open the remote panel.  
👉 "Launching/ Opening/Exiting MSM" P.26

- 2 Go to the Media Setting tab > Adjust > PF Adjust and click [Start].

- The PF Adjust page opens.

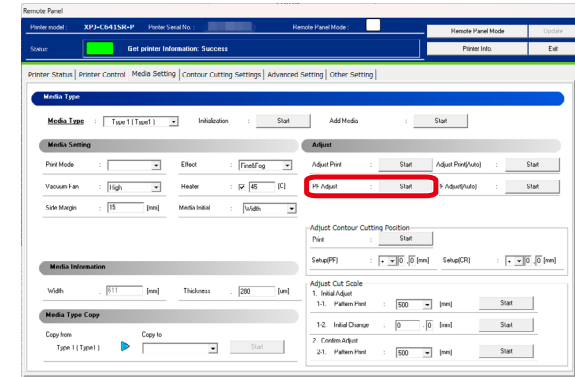

- 3 Go to [1. Initial Adjust] > [1-1 Pattern Print], enter the media feed length (mm) and click [Start].

- Enter the length that your ruler can measure. Increasing feed length will improve accuracy of media feed adjustment.
- The machine prints a pattern.

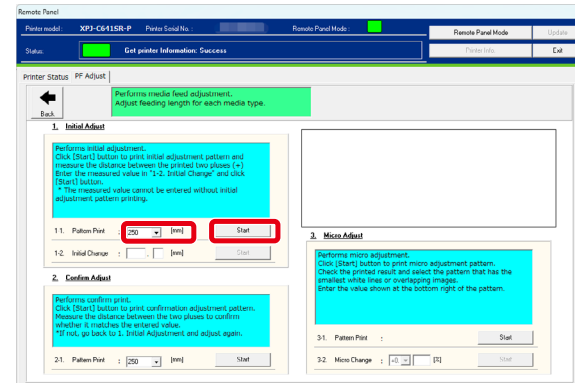

Before Use

Printing workflow

Basic Operations

Powering ON / OFF

Cutting Workflow

Sleep Mode

Maintenance

Loading media into the machine

When problems occur

Nozzle check and cleaning

Appendix

Calibrating your printer

Start printing

Pause / Resume a print job

Cancel a print job

Feed/ Rewind media

Cut the media

High-Capacity ink pack adapter

Adjust head height

Advanced settings

#### 4 Cut the media.

- Long press the operation key on the control panel for more than two seconds.
- The built-in sheet cutter will cut the media.

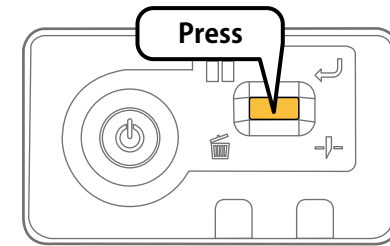

#### 5 Use a ruler to measure the distance between 「+」 marks printed.

- In the illustration below, the distance you will measure is shown in the blue dotted lines and arrows (these lines and arrows will not be printed).

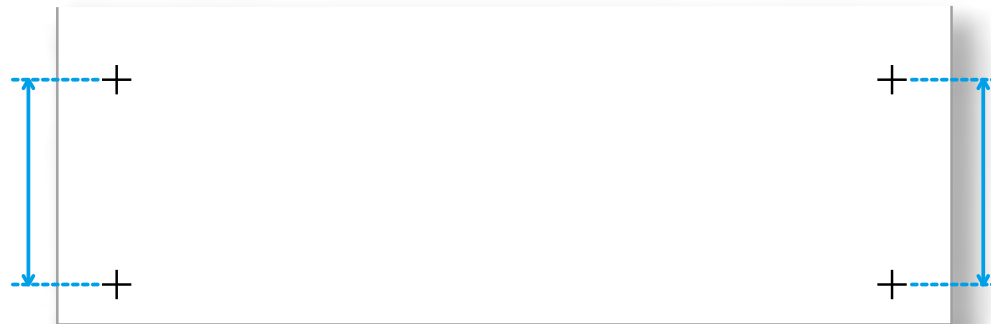

#### 6 Enter the measured length (mm) in 1-2. Initial Change and click [Set].

- This will save the initial adjustment value.
- Move to "2. Confirm Adjust" P.75 .

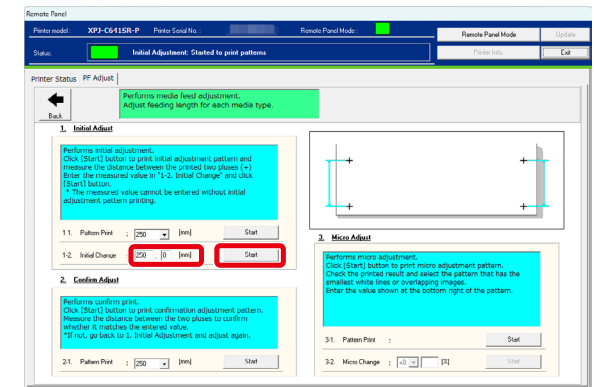

Before Use

Basic Operations

Cutting Workflow

Maintenance

When problems occur

Appendix

Printing workflow

Powering ON / OFF

Sleep Mode

Loading media into the machine

Nozzle check and cleaning

Calibrating your printer

Start printing

Pause / Resume a print job

Cancel a print job

Feed/ Rewind media

Cut the media

High-Capacity ink pack adapter

Adjust head height

Advanced settings

## 2. Confirm Adjust

**1** Go to [2. Confirm Adjust] > [2-1 Pattern Print], enter the media feed length (mm) and click [Start].

- The machine prints a pattern.

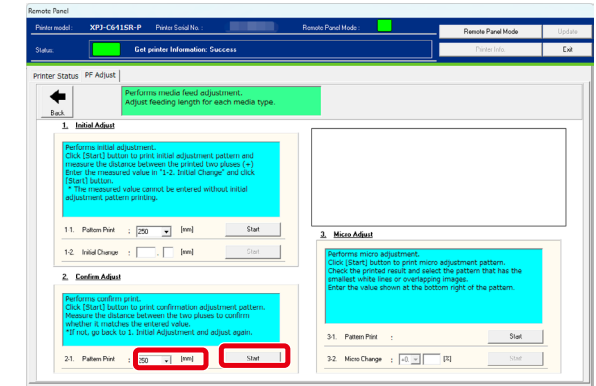

**2** Cut the media.

- Long press the operation key on the control panel for more than two seconds.
- The built-in sheet cutter will cut the media.

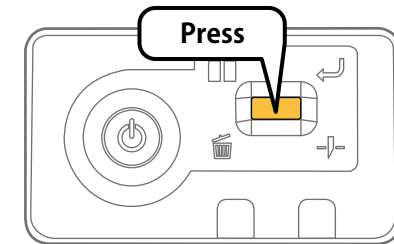

**3** Use a ruler to measure the distance between 「+」 marks printed.

- In the illustration below, the distance you will measure is shown in the blue dotted lines and arrows (these lines and arrows will not be printed).

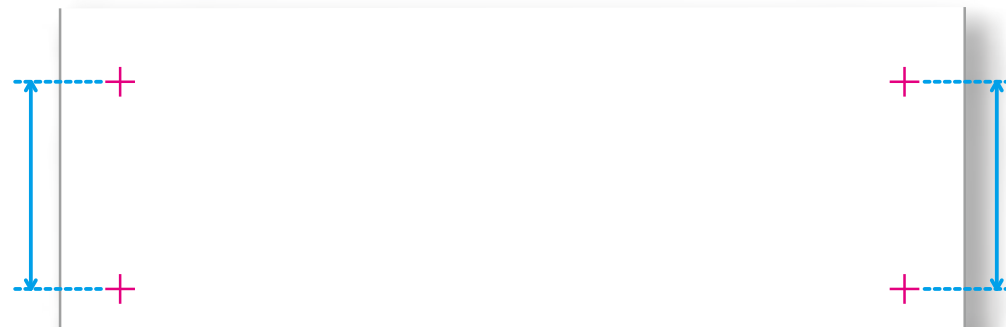

Before Use

Printing workflow

Basic Operations

Powering ON / OFF

Cutting Workflow

Sleep Mode

Maintenance

Loading media into the machine

When problems occur

Nozzle check and cleaning

Appendix

Calibrating your printer

Start printing

Pause / Resume a print job

Cancel a print job

Feed/ Rewind media

Cut the media

High-Capacity ink pack adapter

Adjust head height

Advanced settings

#### 4 Check the measured length.

- If the length entered in Step 1 and the measured distance match: move to "3. Micro Adjust" P.76 .
- If the length entered and the measured distance do not match: go back "1. Initial Print" P.73 and do the adjustment again.

### 3. Micro Adjust

#### 1 Go to [3. Micro Adjust] > [3-1 Pattern Print] and click [Start].

- The machine prints a pattern.

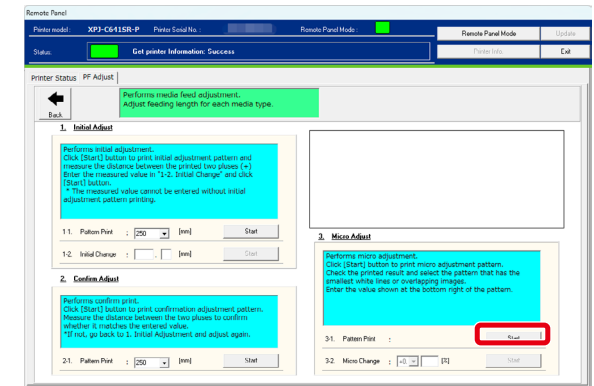

#### 2 Look at the printed pattern and find the micro adjustment value.

- Find the pattern that has least white lines or overlapping.
- The value written under the selected pattern will be the micro adjustment value.

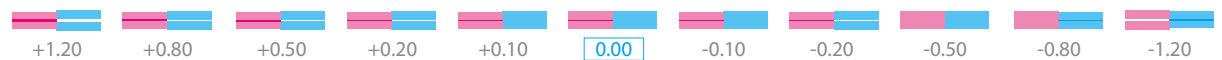
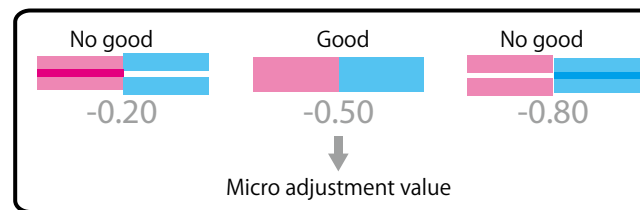

Before Use

Printing workflow

Basic Operations

Powering ON / OFF

Cutting Workflow

Sleep Mode

Maintenance

Loading media into the machine

When problems occur

Nozzle check and cleaning

Appendix

Calibrating your printer

Start printing

Pause / Resume a print job

Cancel a print job

Feed/ Rewind media

Cut the media

High-Capacity ink pack adapter

Adjust head height

Advanced settings

3

In [3-2. Micro Change], enter the micro adjustment value selected in Step 2 and click [Start].

- This will save the micro adjustment value.
- The media feed adjustment is now completed.

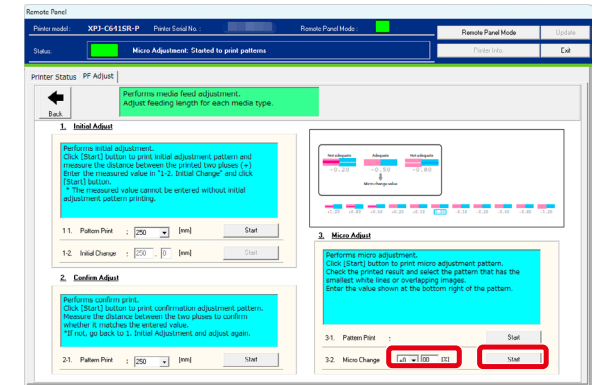

**Note**

Once the micro adjustment value has been saved, the value will become the reference value to be printed in the center of the pattern from the next print.

For example, if you have entered “-0.50” and print a micro adjustment pattern, values printed in the center of the pattern will be changed from 0.00 to -0.50. The value printed on the left side will be +0.70 and the value printed on the right side will be -1.70.

Before Use

Printing workflow

Basic Operations

Powering ON / OFF

Cutting Workflow

Sleep Mode

Maintenance

Loading media into the machine

When problems occur

Nozzle check and cleaning

Appendix

Calibrating your printer

Start printing

Pause / Resume a print job

Cancel a print job

Feed/ Rewind media

Cut the media

High-Capacity ink pack adapter

Adjust head height

Advanced settings

# Start printing

Here we will explain the basic printing procedure using VerteLith.

For the details of VerteLith setup, see the section "Configure initial setup of VerteLith and machine" on XPJ-C641SR-P Startup Guide.

## Important !!

Do not place any objects on the media feeding direction. If media feeding is interrupted, this will affect printing or cutting quality.

1 Before printing, do the following in order.

- 👉 "Loading media into the machine" P.51
- 👉 "Nozzle check and cleaning" P.57
- 👉 "Calibrating your printer" P.63 (if need)

2 Start VerteLith. Select "XPJ-C641SR-P" from the list of printer (1) .

- [XPJ-C641SR-P] will appear (2) .

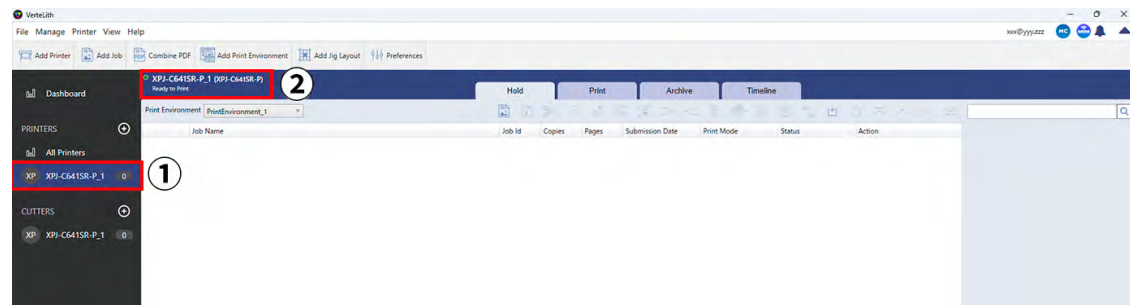

Before Use

Printing workflow

Basic Operations

Powering ON / OFF

Cutting Workflow

Sleep Mode

Maintenance

Loading media into the machine

When problems occur

Nozzle check and cleaning

Appendix

Calibrating your printer

Start printing

Pause / Resume a print job

Cancel a print job

Feed/ Rewind media

Cut the media

High-Capacity ink pack adapter

Adjust head height

Advanced settings

### 3 Add an image file you want to print.

- In the Hold queue, click the [Add Job] icon (1) so that the open dialog appears.

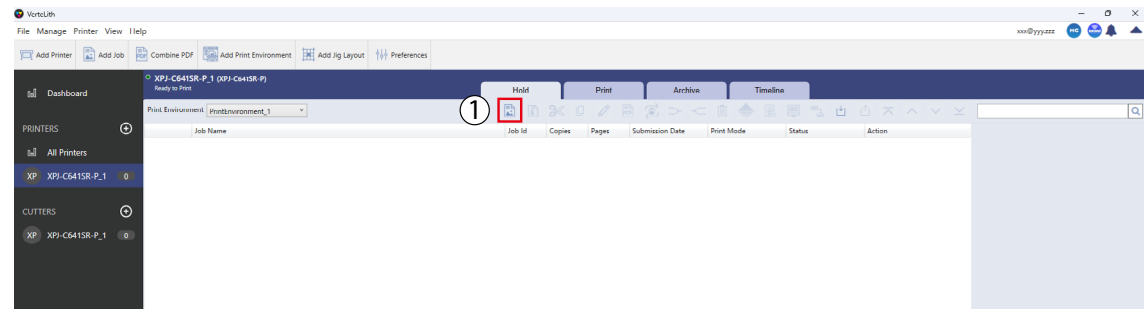

- Select an image file and click [OK] to add it to the Hold queue (2). You can add multiple files here.

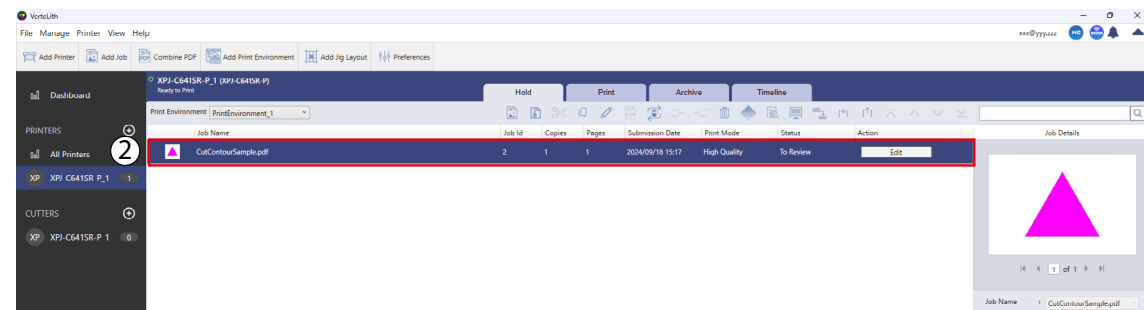

#### Note

You can also drag and drop files in the Hold queue.

Before Use

Printing workflow

Basic Operations

Powering ON / OFF

Cutting Workflow

Sleep Mode

Maintenance

Loading media into the machine

When problems occur

Nozzle check and cleaning

Appendix

Calibrating your printer

Start printing

Pause / Resume a print job

Cancel a print job

Feed/ Rewind media

Cut the media

High-Capacity ink pack adapter

Adjust head height

Advanced settings

4

Select a print job and click [Edit] (1) or [Edit Job] (2)

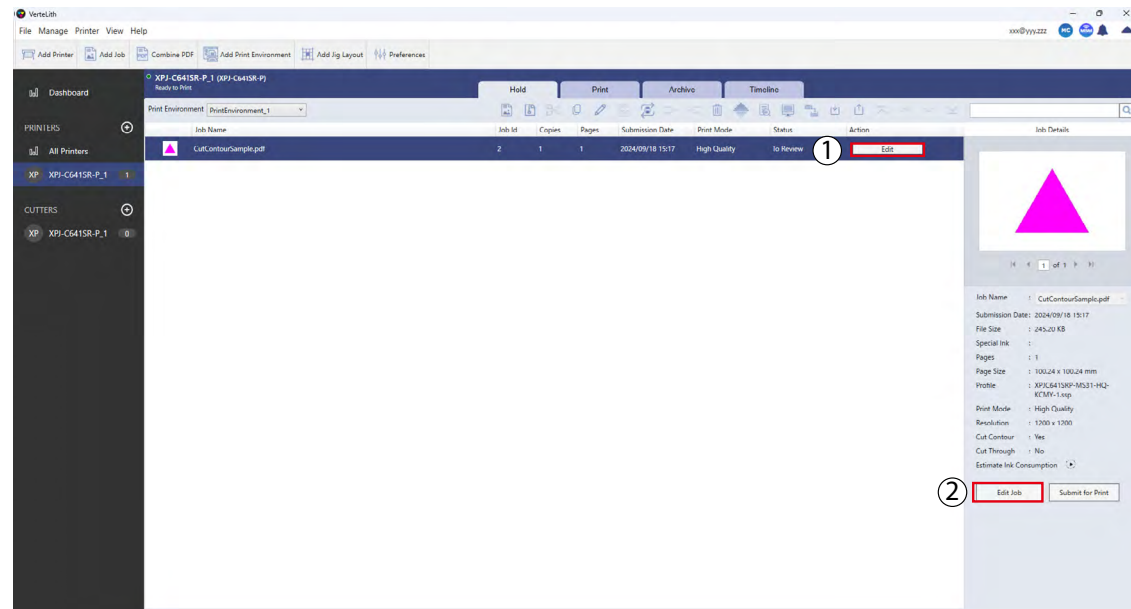



Before Use

Printing workflow

Basic Operations

Powering ON / OFF

Cutting Workflow

Sleep Mode

Maintenance

Loading media into the machine

When problems occur

Nozzle check and cleaning

Appendix

Calibrating your printer

Start printing

Pause / Resume a print job

Cancel a print job

Feed/ Rewind media

Cut the media

High-Capacity ink pack adapter

Adjust head height

Advanced settings

5 [Edit Job Settings] appears. Click the General tab (1) .

Select the output method (2) .

● Print only

The machine only prints designs.

● Print and cut

The machine prints and cut designs when a job contains a cutting data.

👉 "Print & Cut" P.142

● Cutting only

The machine only cuts designs when a job contains a cutting data.

👉 "Cut only" P.144

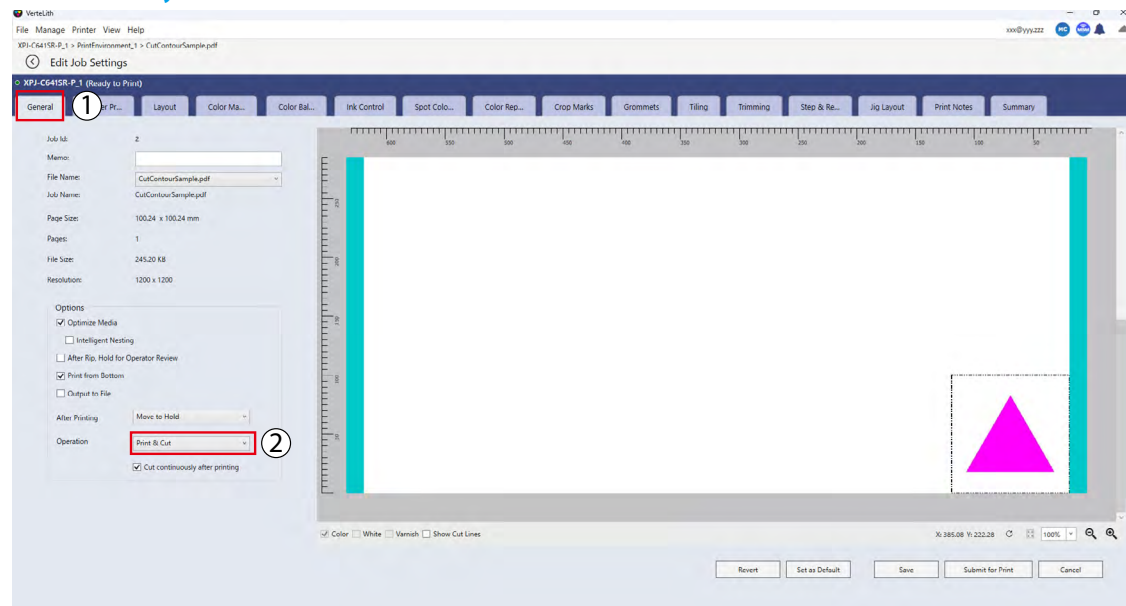

Before Use

Printing workflow

Basic Operations

Powering ON / OFF

Cutting Workflow

Sleep Mode

Maintenance

Loading media into the machine

When problems occur

Nozzle check and cleaning

Appendix

Calibrating your printer

Start printing

Pause / Resume a print job

Cancel a print job

Feed/ Rewind media

Cut the media

High-Capacity ink pack adapter

Adjust head height

Advanced settings

## 6 Click the Printer Profile tab (1) .

Configure the basic print settings.

### ● Profile Group option (2)

Select an appropriate profile group depending on the ink being used.

### ● Profile option (3)

Select an appropriate profile depending on the media type and print mode.

### ● Printer Options (4)

Additional advanced settings can be configured (you can also print with default settings).

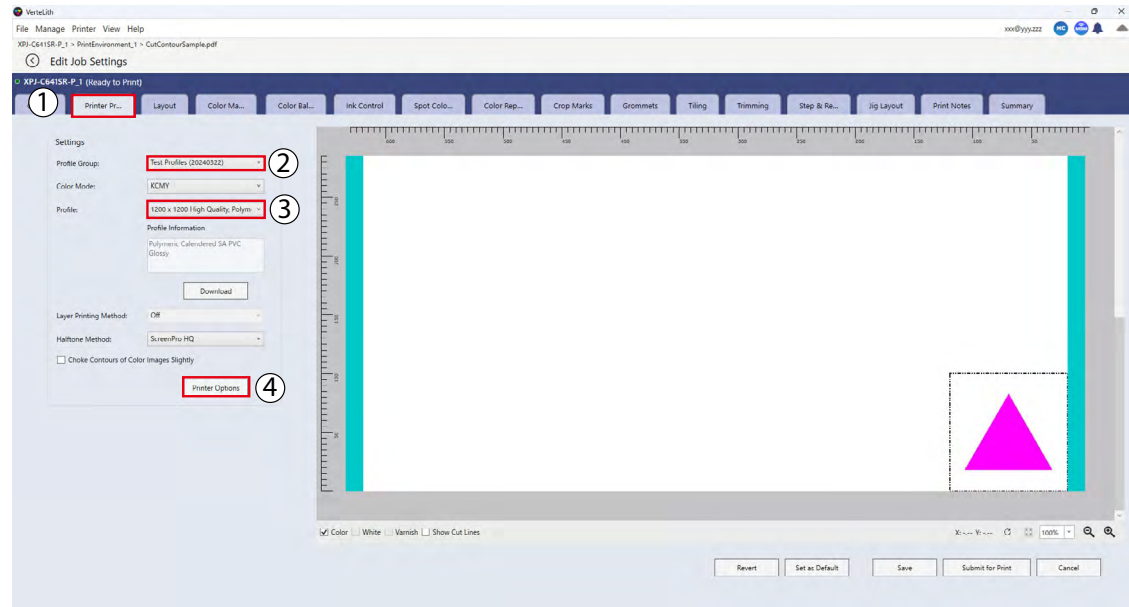

## Before Use

Printing workflow

## Basic Operations

Powering ON / OFF

## Cutting Workflow

Sleep Mode

## Maintenance

Loading media into the machine

## When problems occur

Nozzle check and cleaning

## Appendix

Calibrating your printer

Start printing

Pause / Resume a print job

Cancel a print job

Feed/ Rewind media

Cut the media

High-Capacity ink pack adapter

Adjust head height

Advanced settings

- 7 Once you have set the print settings, click [Submit for Print] (1) so that the job will move to the Print queue. Printing begins after RIP processing.

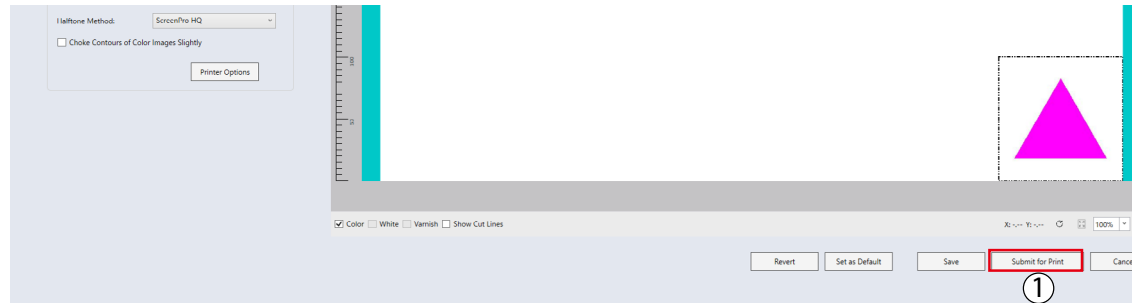

- The processing status of the job (Sending, Waiting for ripping, Ripping, Waiting for Print) can be viewed (2).

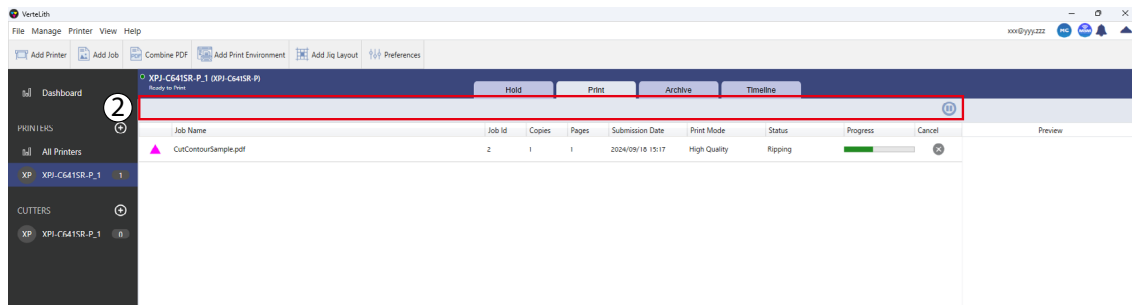

- The job will automatically move to the Hold queue after printing (3).

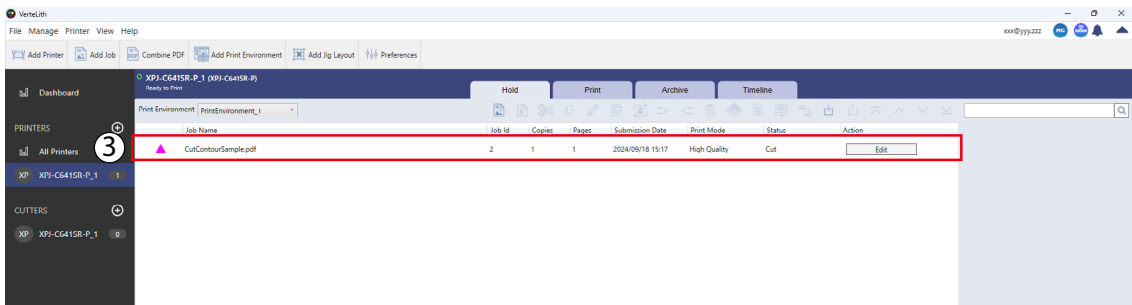

Before Use

Printing workflow

Basic Operations

Powering ON / OFF

Cutting Workflow

Sleep Mode

Maintenance

Loading media into the machine

When problems occur

Nozzle check and cleaning

Appendix

Calibrating your printer

Start printing

**Pause / Resume a print job**

Cancel a print job

Feed/ Rewind media

Cut the media

High-Capacity ink pack adapter

Adjust head height

Advanced settings

# Pause / Resume a print job

**1** Short press the operation key on the control panel while printing.

- The printing will be paused.
- Pressing the operation key again will resume the print job.

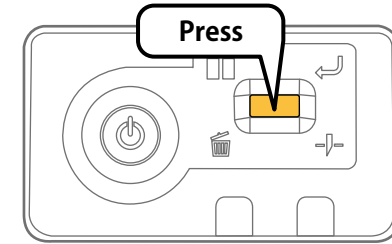

## Note

- This operation does not delete the print job sent to the machine.
- To cancel printing and delete the job, see the following section.

 ["Cancel a print job" P.85](#)

Before Use

Printing workflow

Basic Operations

Powering ON / OFF

Cutting Workflow

Sleep Mode

Maintenance

Loading media into the machine

When problems occur

Nozzle check and cleaning

Appendix

Calibrating your printer

Start printing

Pause / Resume a print job

Cancel a print job

Feed/ Rewind media

Cut the media

High-Capacity ink pack adapter

Adjust head height

Advanced settings

# Cancel a print job

## Cancel printing from the machine

1 Press the operation key on the control panel for more than two seconds.

- Printing is canceled (it cannot be resumed).
- The print job sent to the machine is deleted.

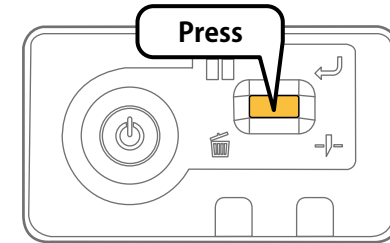

## Cancel printing from the computer

1 Start MSM while printing and open the remote panel.  
👉 ["Launching/ Opening/Exiting MSM" P.26](#)

2 In the Printer Control menu, click [Print Cancel].  
• A confirmation message appears.



Before Use	Printing workflow
<b>Basic Operations</b>	Powering ON / OFF
Cutting Workflow	Sleep Mode
Maintenance	Loading media into the machine
When problems occur	Nozzle check and cleaning
Appendix	Calibrating your printer
	Start printing
	Pause / Resume a print job
	<b>Cancel a print job</b>
	Feed/ Rewind media
	Cut the media
	High-Capacity ink pack adapter
	Adjust head height
	Advanced settings

- 3 Click [Yes].
  - This will cancel printing.

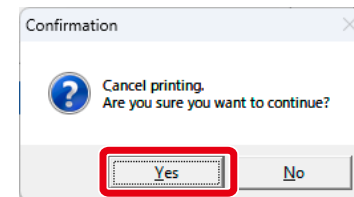

Before Use

Printing workflow

Basic Operations

Powering ON / OFF

Cutting Workflow

Sleep Mode

Maintenance

Loading media into the machine

When problems occur

Nozzle check and cleaning

Appendix

Calibrating your printer

Start printing

Pause / Resume a print job

Cancel a print job

Feed/ Rewind media

Cut the media

High-Capacity ink pack adapter

Adjust head height

Advanced settings

# Feed/ Rewind media

- 1 Start MSM and open the remote panel.  
👉 "Launching/ Opening/Exiting MSM" P.26

- 2 Click the Printer Control tab.
  - The Printer Control tab page opens.

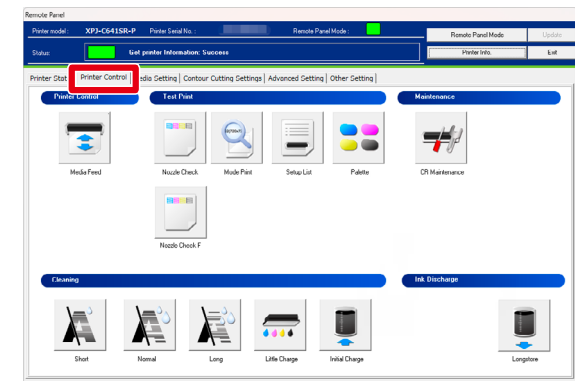

- 3 In the Printer Control menu, click [Media Feed].
  - The Media Feed page appears.

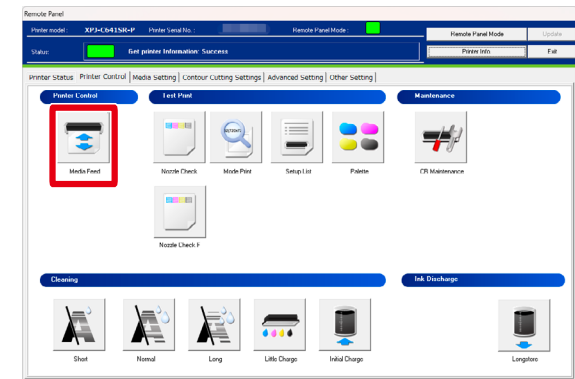

Before Use

Printing workflow

Basic Operations

Powering ON / OFF

Cutting Workflow

Sleep Mode

Maintenance

Loading media into the machine

When problems occur

Nozzle check and cleaning

Appendix

Calibrating your printer

Start printing

Pause / Resume a print job

Cancel a print job

Feed/ Rewind media

Cut the media

High-Capacity ink pack adapter

Adjust head height

Advanced settings

4

Clicking [Backward Feed] or [Forward Feed] will feed the media backward or forward.

- Clicking [Stop] during this operation will stop the media feeding.
- You can also press the operation key on the control panel to stop the media feeding.

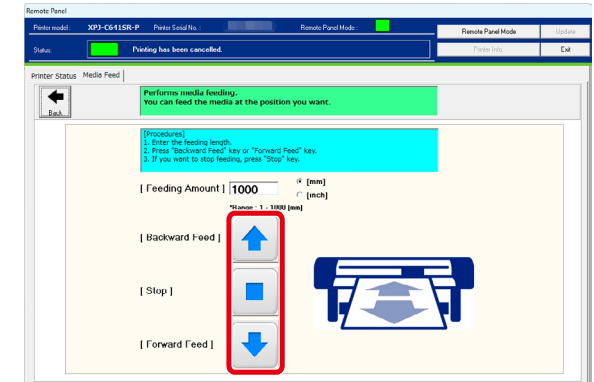



Before Use

Printing workflow

Basic Operations

Powering ON / OFF

Cutting Workflow

Sleep Mode

Maintenance

Loading media into the machine

When problems occur

Nozzle check and cleaning

Appendix

Calibrating your printer

Start printing

Pause / Resume a print job

Cancel a print job

Feed/ Rewind media

Cut the media

High-Capacity ink pack adapter

Adjust head height

Advanced settings

# Cut the media

This section explains how to cut the sheet off the roll media.

For contour cutting (cutting out around the design), see "Advanced Operation" in this document.

## Cut from the control panel

- 1 Check that printing has finished.
- 2 Long press the operation key on the control panel.
  - The built-in sheet cutter will cut the media.

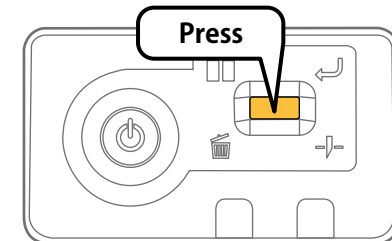

Before Use

Printing workflow

Basic Operations

Powering ON / OFF

Cutting Workflow

Sleep Mode

Maintenance

Loading media into the machine

When problems occur

Nozzle check and cleaning

Appendix

Calibrating your printer

Start printing

Pause / Resume a print job

Cancel a print job

Feed/ Rewind media

Cut the media

High-Capacity ink pack adapter

Adjust head height

Advanced settings

## Cut from the computer

- 1 Check that printing has finished.
- 2 Start MSM and open the remote panel.  
👉 "Launching/ Opening/Exiting MSM" P.26

- 3 Click the Printer Status tab and click [Media Cut] in the Printer Control menu.

- The confirmation message appears.

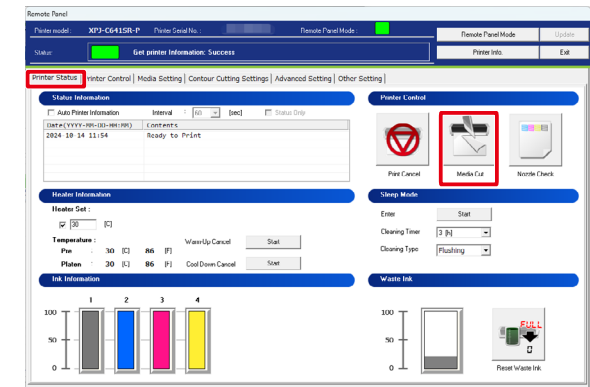

- 4 Click [Yes].

- The built-in sheet cutter will cut the media.

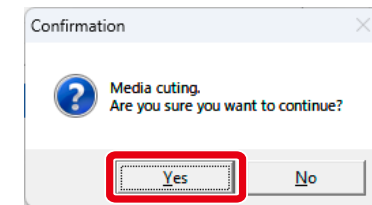

Before Use

Basic Operations

Cutting Workflow

Maintenance

When problems occur

Appendix

Printing workflow

Powering ON / OFF

Sleep Mode

Loading media into the machine

Nozzle check and cleaning

Calibrating your printer

Start printing

Pause / Resume a print job

Cancel a print job

Feed/ Rewind media

Cut the media

High-Capacity ink pack adapter

Adjust head height

Advanced settings

## Cut manually

For the media that the built-in sheet cutter is unable to cut, follow these steps to cut it manually.

1 Check that printing has finished.

2 Advance the media to the position where you can cut the printed result.

 "Feed/ Rewind media" P.87

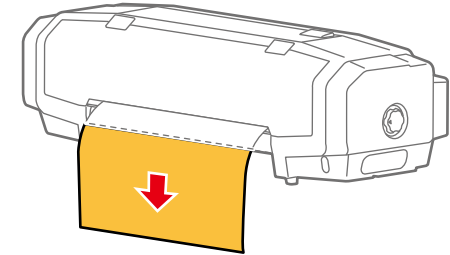

3 Open the front cover and cut the media using your personal cutter.

- Cut it along the media cut groove.

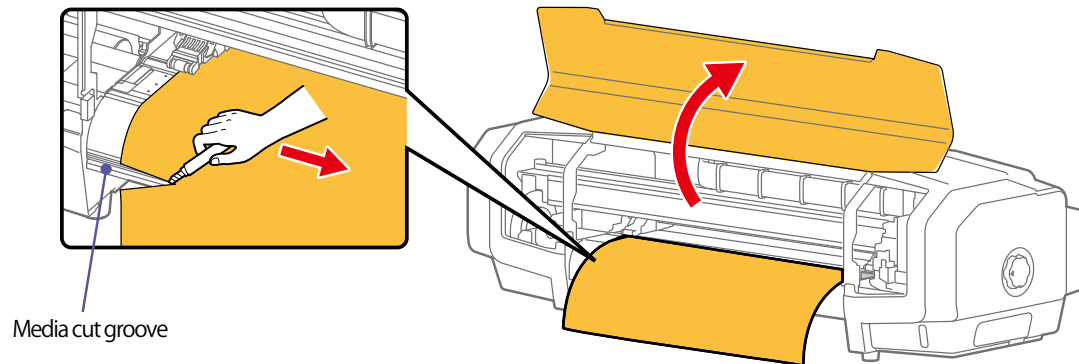

4 Close the front cover.

Before Use

Basic  
Operations

Cutting  
Workflow

Maintenance

When problems  
occur

Appendix

Printing workflow

Powering ON / OFF

Sleep Mode

Loading media into the  
machine

Nozzle check and cleaning

Calibrating your printer

Start printing

Pause / Resume a print job

Cancel a print job

Feed/ Rewind media

Cut the media

High-Capacity ink pack  
adapter

Adjust head height

Advanced settings

## Cut automatically

This product has the function to automatically cut the media each time after printing.

 ["Set up auto cutting" P.96](#)

Before Use

Printing workflow

Basic Operations

Powering ON / OFF

Cutting Workflow

Sleep Mode

Maintenance

Loading media into the machine

When problems occur

Nozzle check and cleaning

Appendix

Calibrating your printer

Start printing

Pause / Resume a print job

Cancel a print job

Feed/ Rewind media

Cut the media

High-Capacity ink pack adapter

Adjust head height

Advanced settings

# High-Capacity ink pack adapter

For how to attach a 1000ml ink bag to the high-capacity ink pack adapter, see the high-capacity ink pack adapter operation manual.

## When using the high-capacity ink pack adapter for the first time

In the following cases, air in the high-capacity ink pack adapter may enter the ink lines in the machine, causing nozzle clogging.

- When you install the high-capacity ink pack adapter on the machine already filled with ink.
- When the high-capacity ink pack adapter was already used on the machine and you replace with a new high-capacity ink pack adapter to install.

To avoid this, make sure to perform an initial ink charging from the remote panel on MSM.

For initial ink charging procedure, see the following section.

 ["Performing initial ink charging" P.213](#)

## Replace the adapter's plug

The plug of the high-capacity ink pack adapter needs to be replaced when the high-capacity ink pack adapter has been removed/installed for a certain number of times.

For the detailed procedure, see the following section.

 ["Replacing the adapter's plug for high-capacity ink pack adapter" P.197](#)

Before Use

Printing workflow

Basic Operations

Powering ON / OFF

Cutting Workflow

Sleep Mode

Maintenance

Loading media into the machine

When problems occur

Nozzle check and cleaning

Appendix

Calibrating your printer

Start printing

Pause / Resume a print job

Cancel a print job

Feed/ Rewind media

Cut the media

High-Capacity ink pack adapter

Adjust head height

Advanced settings

# Adjust head height

## About head height

Normally set the head height to "Low". Avoid using the machine with High setting unless a head strike occurs with Low setting. The closer the gap between the media and the printhead, the better the consistency of the print quality.

### Important!!

Depending on the condition of a roll media or media cockling caused by the printer settings, you may get a head strike causing ink smears on the media. In such cases, try followings:

- Reduce the heater temperature setting
  - ☞ "Specify the heater setting" P.101
- After you change the head height, make sure to perform the print quality calibration.
  - ☞ "Print quality calibration ("Adjust Print")" P.63
- Do not open the front cover and change the head height during printing. Print quality cannot be guaranteed.

See the following table for the relationship between the head height and the recommended media thickness. Avoid using higher head height unless absolutely necessary, as the wider head gap will cause ink mist to adhere to the printhead nozzles, media or inside of the printer, adversely affecting print quality or leading to damage to the printer parts.

Head height	Recommended media thickness	Maximum media thickness that printer can feed	Description
Low	~ 0.3 mm	0.4 mm	Normally use this head height.

(Maximum thickness that media can pass through the media path : 0.8 mm)

Before Use

Printing workflow

Basic Operations

Powering ON / OFF

Cutting Workflow

Sleep Mode

Maintenance

Loading media into the machine

When problems occur

Nozzle check and cleaning

Appendix

Calibrating your printer

Start printing

Pause / Resume a print job

Cancel a print job

Feed/ Rewind media

Cut the media

High-Capacity ink pack adapter

Adjust head height

Advanced settings

## Changing the head height

- 1 Open the front cover.
- 2 Raise the head height adjustment lever and change the print head height.

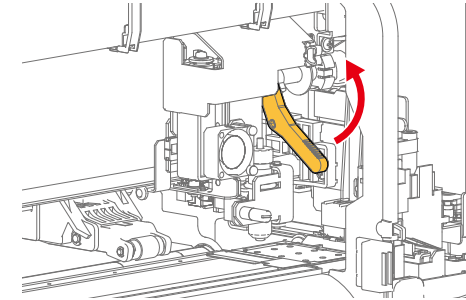

- 3 Close the front cover.
- 4 Perform print quality calibration.  
👉 ["Print quality calibration \("Adjust Print"\)" P.63](#)

### Important!!

Do not change the print head height while printing.

Before Use

Printing workflow

Basic Operations

Powering ON / OFF

Cutting Workflow

Sleep Mode

Maintenance

Loading media into the machine

When problems occur

Nozzle check and cleaning

Appendix

Calibrating your printer

Start printing

Pause / Resume a print job

Cancel a print job

Feed/ Rewind media

Cut the media

High-Capacity ink pack adapter

Adjust head height

Advanced settings

# Advanced settings

You can change the printer settings according to your usage.

Here we introduce some of the functions. For more information on how to use MSM, see the MSM operation manual.

## Set up auto cutting

You can configure the setting to automatically cut the media once printing is complete.

Specify this setting appropriately depending on the width, thickness or material of media.

### Note

This option may not cut off some types of media. In such cases, cut it manually.

## Procedure

- 1 Start MSM and open the remote panel.  
👉 ["Launching/ Opening/Exiting MSM" P.26](#)
- 2 Go to the [Media Setting] tab > [Media Initial] menu and select other than "Off".

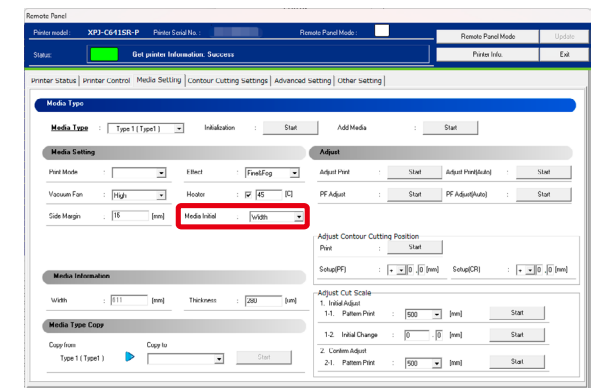



Before Use

Printing workflow

Basic Operations

Powering ON / OFF

Cutting Workflow

Sleep Mode

Maintenance

Loading media into the machine

When problems occur

Nozzle check and cleaning

Appendix

Calibrating your printer

Start printing

Pause / Resume a print job

Cancel a print job

Feed/ Rewind media

Cut the media

High-Capacity ink pack adapter

Adjust head height

Advanced settings

3

Go to the [Advanced Setting] tab > [Output Mode] menu and select [Auto Cut].

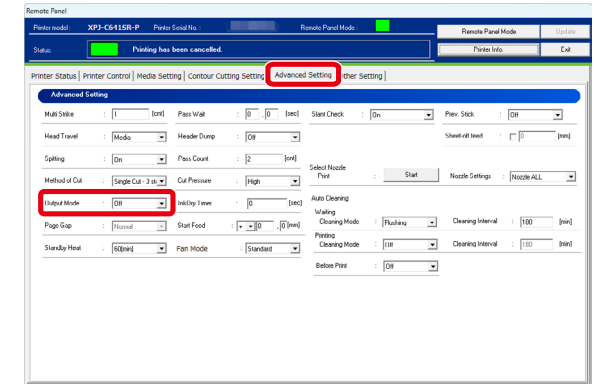

4

From the [Method of Cut] menu, select the cutting method.

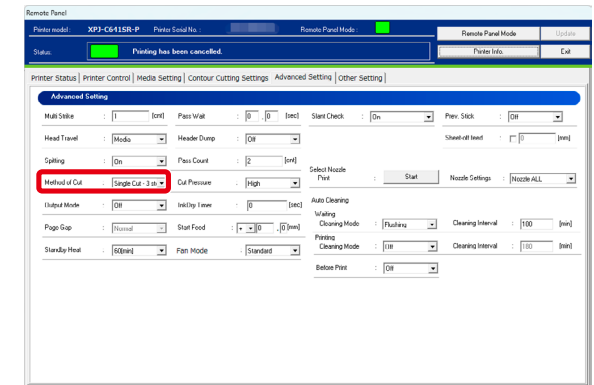

The cutting method has the following modes:

Single Cut - 2 steps : Cut with less process than "Single Cut - 3 steps." This option is suitable for narrow-width media.

Single Cut - 3 steps : Normal cutting method.

Double Cut - 2 steps : Select this when "Single Cut - 2 steps" cannot fully cut the media. This option is suitable for narrow-width media.

Double Cut - 3 steps : Select this when "Single Cut - 3 steps" cannot fully cut the media.

Before Use

Printing workflow

Basic Operations

Powering ON / OFF

Cutting Workflow

Sleep Mode

Maintenance

Loading media into the machine

When problems occur

Nozzle check and cleaning

Appendix

Calibrating your printer

Start printing

Pause / Resume a print job

Cancel a print job

Feed/ Rewind media

Cut the media

High-Capacity ink pack adapter

Adjust head height

Advanced settings

**5** From the [Cut Pressure] menu, select the cutting force between [High] and [Low].

- Use [Low] for thin media.

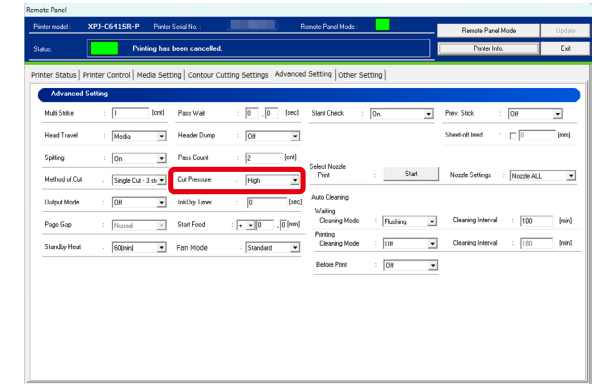

**6** Click [Update].

- This will save the change in the machine.

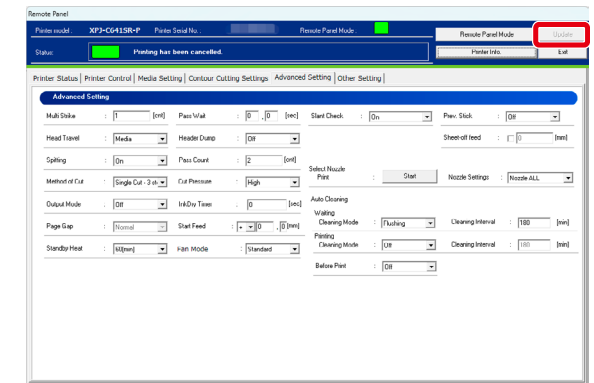

Before Use

Basic Operations

Cutting Workflow

Maintenance

When problems occur

Appendix

Printing workflow

Powering ON / OFF

Sleep Mode

Loading media into the machine

Nozzle check and cleaning

Calibrating your printer

Start printing

Pause / Resume a print job

Cancel a print job

Feed/ Rewind media

Cut the media

High-Capacity ink pack adapter

Adjust head height

Advanced settings

## Set up vacuum fan

When printing on thin or soft media, wrinkles or media jam can be prevented by turning down the vacuum fan.

### Procedure

- 1 Start MSM and open the remote panel.  
👉 "Launching/ Opening/Exiting MSM" P.26
- 2 Click the [Media Setting] tab.
  - The [Media Setting] tab page appears.

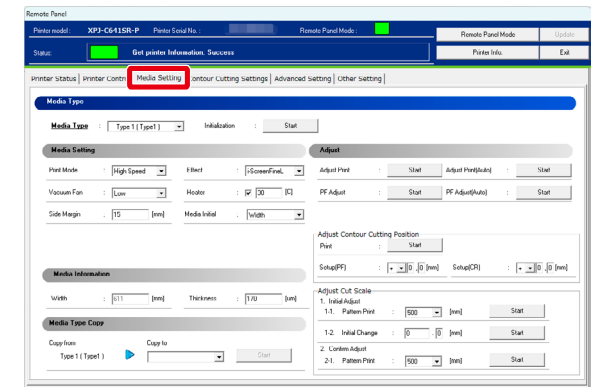

- 3 Select the type of media from the [Media Type] menu.

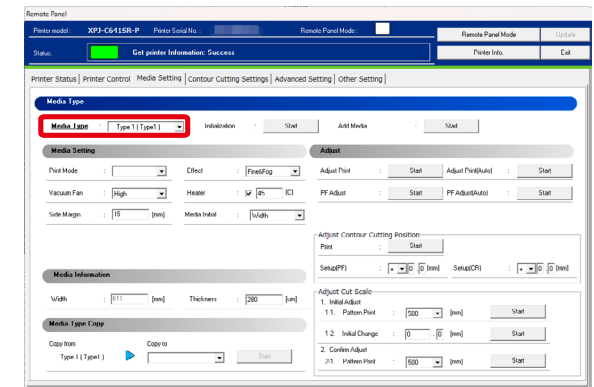

## Before Use

Printing workflow

## Basic Operations

Powering ON / OFF

## Cutting Workflow

Sleep Mode

## Maintenance

Loading media into the machine

## When problems occur

Nozzle check and cleaning

## Appendix

Calibrating your printer

Start printing

Pause / Resume a print job

Cancel a print job

Feed/ Rewind media

Cut the media

High-Capacity ink pack adapter

Adjust head height

Advanced settings

### 4 From the [Vacuum fan] menu, select the mode.

- Option: Off/ Low/ Medium/ High  
\*The underlined option is the default setting.

#### Note

While printing, the setting specified in the print data has priority.

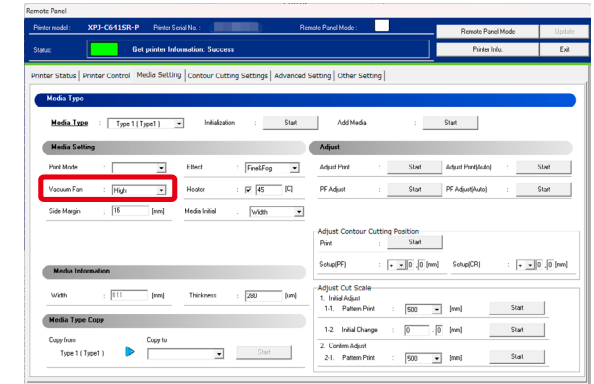

### 5 Click [Update].

- This will save the change in the machine.

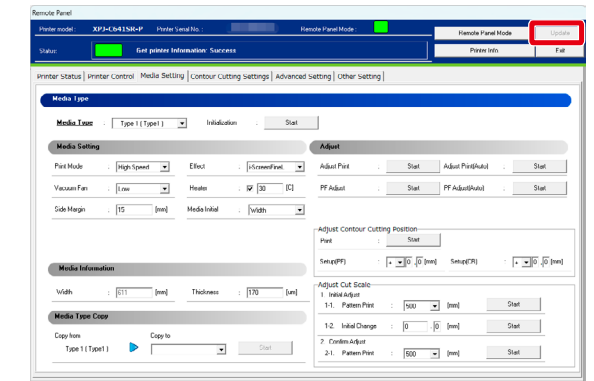

Before Use

Printing workflow

Basic Operations

Powering ON / OFF

Cutting Workflow

Sleep Mode

Maintenance

Loading media into the machine

When problems occur

Nozzle check and cleaning

Calibrating your printer

Appendix

Start printing

Pause / Resume a print job

Cancel a print job

Feed/ Rewind media

Cut the media

High-Capacity ink pack adapter

Adjust head height

Advanced settings

## Specify the heater setting

Heater is used to heat media before or after printing in order to improve print quality or accelerate ink drying. Better results can be obtained by changing the heater settings depending on the thickness or material of media.

### Important !!

For cutting, set the heater to [Off]. If the printed media is still hot, it will affect cutting quality.

## Procedure

1 Start MSM and open the remote panel.  
☞ "Launching/ Opening/Exiting MSM" P.26

2 Click the [Media Setting] tab.

- The [Media Setting] tab page appears.

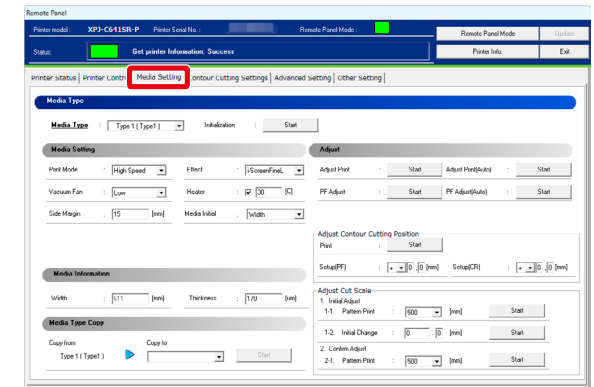

## Before Use

Printing workflow

## Basic Operations

Powering ON / OFF

## Cutting Workflow

Sleep Mode

## Maintenance

Loading media into the machine

## When problems occur

Nozzle check and cleaning

## Appendix

Calibrating your printer

Start printing

Pause / Resume a print job

Cancel a print job

Feed/ Rewind media

Cut the media

High-Capacity ink pack adapter

Adjust head height

Advanced settings

3

Select the type of media from the [Media Type] menu.

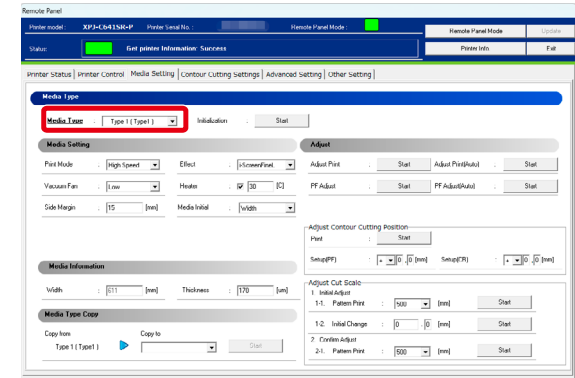

4

From the [Heater] menu, specify the heater temperature.

- Setting range: Off / 30 - 45°C
- \*The underlined option is the default setting.

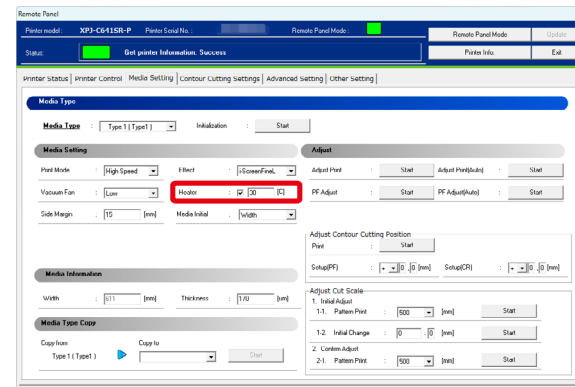

5

Click [Update].

- This will save the change in the machine.

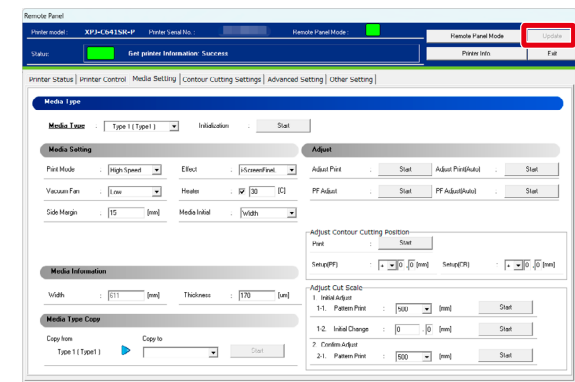

Before Use

Printing workflow

Basic Operations

Powering ON / OFF

Cutting Workflow

Sleep Mode

Maintenance

Loading media into the machine

When problems occur

Nozzle check and cleaning

Appendix

Calibrating your printer

Start printing

Pause / Resume a print job

Cancel a print job

Feed/ Rewind media

Cut the media

High-Capacity ink pack adapter

Adjust head height

Advanced settings

## Cooling down setting

This menu allows you to cool down the machine for a certain period before cutting to avoid impact of heat on cutting.

### Procedure

- 1 Start MSM and open the remote panel.  
☞ "Displaying remote panel" P.27
- 2 Click the [Contour Cutting Settings] tab.

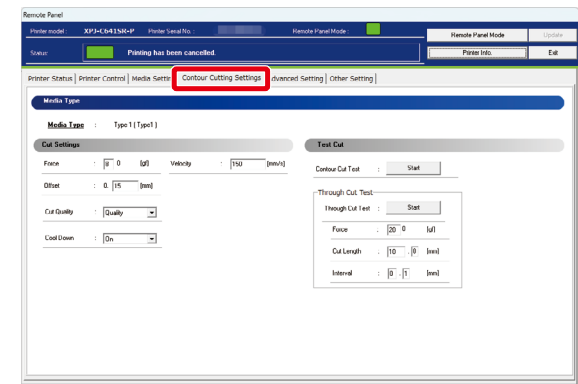

- 3 In the [Cool Down] menu, select [ON].
  - Option: OFF/ON  
\*The underline shows the default setting.
  - On : After printing, the machine waits for the platen temperature to drop below 35 degrees C before reading crop marks and cutting. If the platen temperature does not drop below 35 degrees C after 10 minutes, the machine will stop cooling down and start the next operation.
  - Off : After printing, the machine begins reading crop marks or cutting without any waiting time.

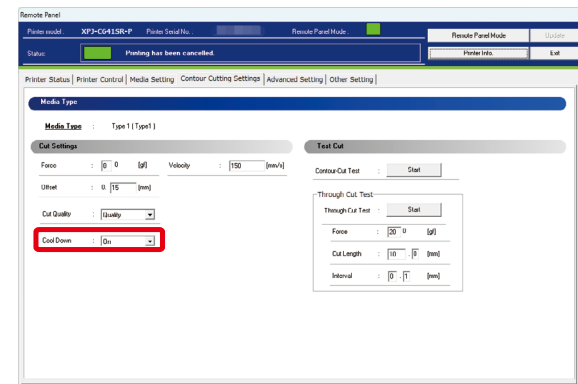

Before Use

Printing workflow

Basic Operations

Powering ON / OFF

Cutting Workflow

Sleep Mode

Maintenance

Loading media into the machine

When problems occur

Nozzle check and cleaning

Appendix

Calibrating your printer

Start printing

Pause / Resume a print job

Cancel a print job

Feed/ Rewind media

Cut the media

High-Capacity ink pack adapter

Adjust head height

Advanced settings

4 Click [Update].

- This will save the change in the machine.

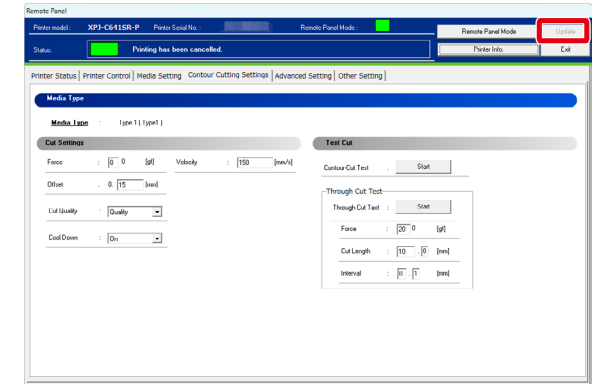



Before Use

Printing workflow

Basic Operations

Powering ON / OFF

Cutting Workflow

Sleep Mode

Maintenance

Loading media into the machine

When problems occur

Nozzle check and cleaning

Appendix

Calibrating your printer

Start printing

Pause / Resume a print job

Cancel a print job

Feed/ Rewind media

Cut the media

High-Capacity ink pack adapter

Adjust head height

Advanced settings

## Specify the ink drying time

Specify the ink drying time before cutting.

### Procedure

1 Start MSM and open the remote panel.  
☞ "Launching/ Opening/Exiting MSM" P.26

2 Click the [Advanced Setting] tab.

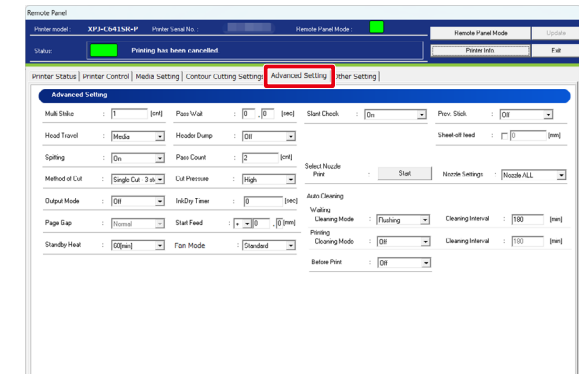

3 In the [Ink Dry Timer] menu, enter the drying time in second.

- Setting range: 0 to 3600 seconds (60 minutes)  
\*The underline shows the default setting.

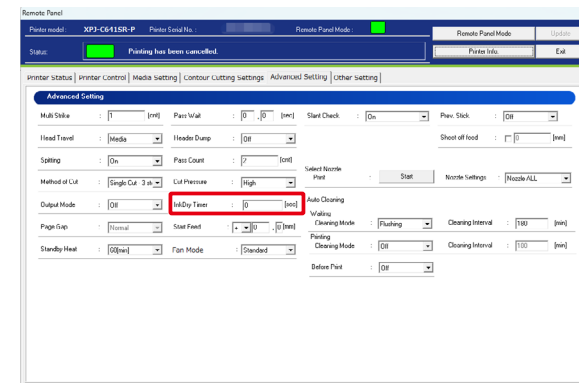

Before Use

Printing workflow

Basic Operations

Powering ON / OFF

Cutting Workflow

Sleep Mode

Maintenance

Loading media into the machine

When problems occur

Nozzle check and cleaning

Appendix

Calibrating your printer

Start printing

Pause / Resume a print job

Cancel a print job

Feed/ Rewind media

Cut the media

High-Capacity ink pack adapter

Adjust head height

Advanced settings

4 Click [Update].

- This will save the change in the machine.

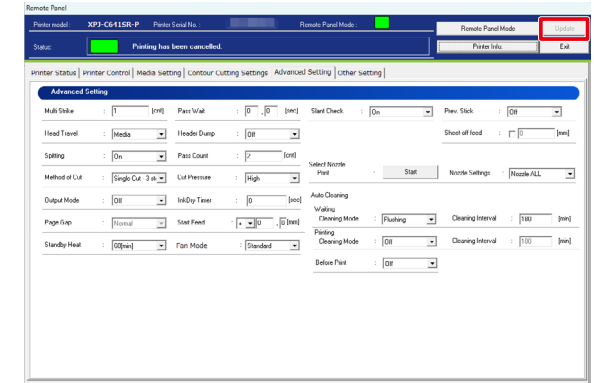

Before Use

Printing workflow

Basic Operations

Powering ON / OFF

Cutting Workflow

Sleep Mode

Maintenance

Loading media into the machine

When problems occur

Nozzle check and cleaning

Appendix

Calibrating your printer

Start printing

Pause / Resume a print job

Cancel a print job

Feed/ Rewind media

Cut the media

High-Capacity ink pack adapter

Adjust head height

Advanced settings

## Roll Length Manage menu

This menu allows you to check and change the remaining length information of roll media being loaded in the printer.

### Note

- This menu will not be displayed when the "Media Initial" menu is set to [Off] on MSM.
- This menu will not be displayed when no roll media is loaded in the printer.
- "Print" or "Simple Print" requires at least 400 mm printable width. Before printing, make sure that there is sufficient width on the media.
- If printable width is less than 400 mm, the printer will not perform printing. Printable width on the media can be adjusted by changing CR origin and side margin (left and right side margin) settings.

## Procedures

- 1 Start MSM and open the remote panel.  
👉 "Displaying remote panel" P.27

- 2 Click the Other Setting tab.

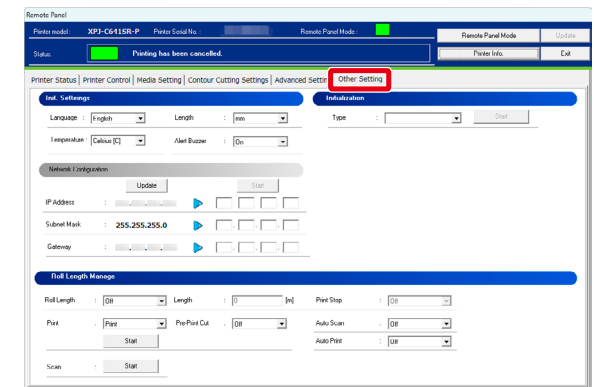

## Before Use

Printing workflow

## Basic Operations

Powering ON / OFF

## Cutting Workflow

Sleep Mode

## Maintenance

Loading media into the machine

## When problems occur

Nozzle check and cleaning

Calibrating your printer

## Appendix

Start printing

Pause / Resume a print job

Cancel a print job

Feed/ Rewind media

Cut the media

High-Capacity ink pack adapter

Adjust head height

Advanced settings

**3** In the Roll Length Manage menu, specify the following settings. Up to 3 roll media can be managed.

- [Roll Length]: Select a roll media.
  - Options: Off / Roll1 / Roll2 / Roll3
  - \*The underlined option is the default setting.
- [Length]: Enter the length of roll media (m) being loaded.
  - Setting range: 1 m to 30 m to 200 m
  - \*The underlined option is the default setting.
- [Print Stop]: Select whether or not to pause printing when the remaining length of loaded roll media reaches 0 (m).
  - Options: Off / On
  - \*The underlined option is the default setting.

### Note

- When you replace a roll media, set the Roll Length menu again. Remaining roll length may not be displayed correctly if it is not set.
- The [Print Stop] menu is enabled only when the [Roll Length] menu is set to other than Off.

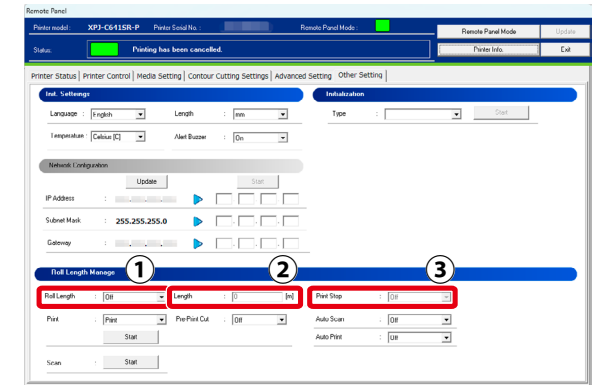

**4** Click [Update].

- This will save the change in the machine.

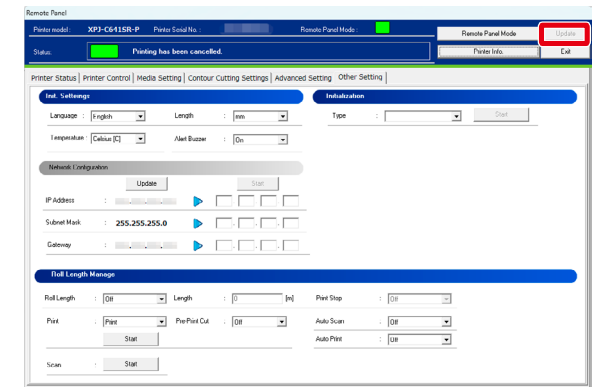

# Cutting Workflow

**Cut Preparation** 110

**Print and cut separately** 133

**Print & Cut** 142

**Cut only** 144

**Optimize cut quality** 146

Before Use

Basic  
Operations

Cutting  
Workflow

Maintenance

When problems  
occur

Appendix

Cut Preparation

Print and cut separately

Print & Cut

Cut only

Optimize cut quality

# Cut Preparation

## Preparation flow for cutting

The following is the preparation flow for cutting.

### 1. Install a blade for contour cut on the blade holder.

👉 "Install a blade on the blade holder" P.111

### 2. Adjust the blade depth.

👉 "Adjust blade depth" P.113

### 3. Install the blade holder on the machine.

👉 "Install the blade holder into the machine" P.115

### 4. Run a test cut and adjust as needed.

👉 "Run a test cut" P.118

👉 "Adjust the contour cutting position" P.126

Before Use

Basic Operations

Cutting Workflow

Maintenance

When problems occur

Appendix

Cut Preparation

Print and cut separately

Print & Cut

Cut only

Optimize cut quality

## Install a blade on the blade holder

### Name of each part on blade holder

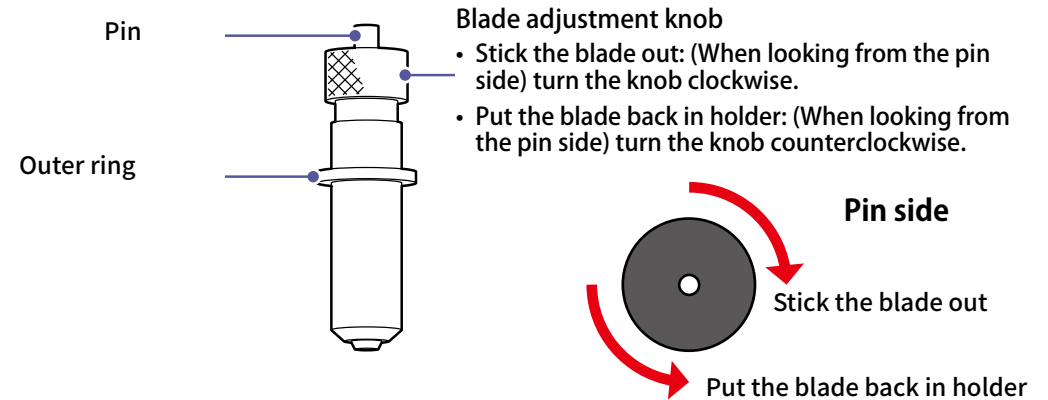

#### Note

The blade is installed on the blade holder when the machine is shipped from the factory.

#### Caution

Press the pin so that the blade comes out. When pressing, keep your finger away from the tip of holder.

### Installing a blade

- 1 Insert the blade into the blade holder.
  - When more than two-third of the blade is inserted, it will be attached by magnetic force.

#### Important!

Using a soft object such as paper, lightly push the tip of the blade holder and check that the blade is in place properly.

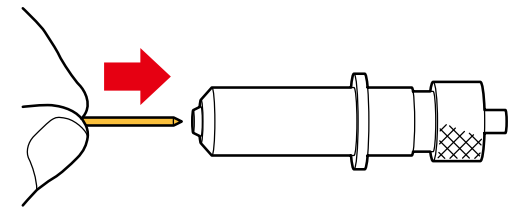

Before Use

Basic Operations

Cutting Workflow

Maintenance

When problems occur

Appendix

Cut Preparation

Print and cut separately

Print & Cut

Cut only

Optimize cut quality

## Removing a blade

- 1 Press the pin so that the blade comes out. Grab the blade and pull it from the holder.

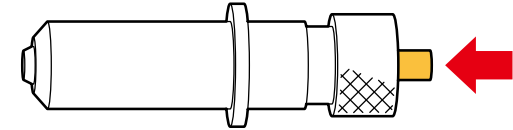



Before Use

Basic Operations

Cutting Workflow

Maintenance

When problems occur

Appendix

Cut Preparation

Print and cut separately

Print & Cut

Cut only

Optimize cut quality

## Adjust blade depth

### Target blade depth

One revolution of adjustment knob : 0.5mm

$$\text{Blade depth} = \text{Thickness of film} + \text{Thickness of backing material} / 2$$

### Example of blade depth

When the media thickness is 0.3mm

(Thickness of film: 0.1 mm, Thickness of backing material: 0.2mm) :

$$\text{Blade depth} = 0.1\text{mm} + (0.2\text{mm}/2) = 0.2\text{mm}$$

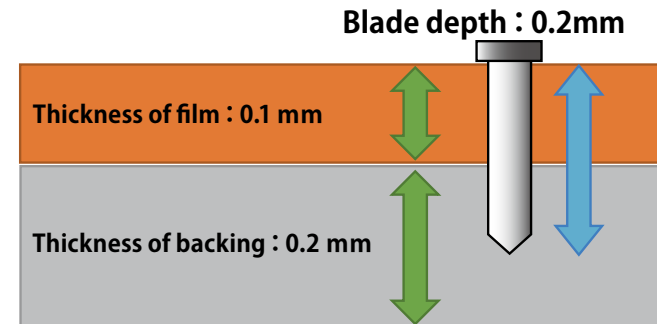

Use the above as a guide when making an adjustment.

#### Note

- The above is the adjustment for contour cutting. For through cutting, adjust the blade depth so that the blade cuts through the backing material.

Blade depth for through cutting = Thickness of film + Thickness of backing material + 0.1 mm

- For a cut data containing both contour and through cutting, you should adjust the blade to the depth for through cutting.

👉 ["Cutting types" P.129](#) , ["Create a cutting data" P.130](#)

Before Use

Basic Operations

Cutting Workflow

Maintenance

When problems occur

Appendix

Cut Preparation

Print and cut separately

Print & Cut

Cut only

Optimize cut quality

## Adjustment steps

- 1 Turn the adjustment knob counterclockwise so that the tip of blade and the tip of blade holder are at the same position.

### Important!

Check that the tip of the blade is not sticking out.

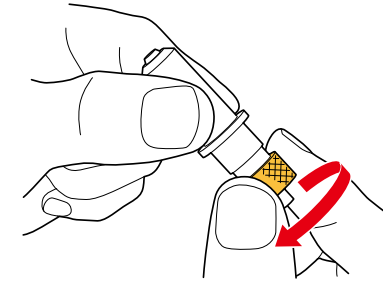
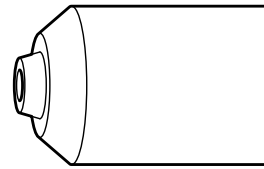

- 2 Calculate the blade depth using the calculation formula of target blade depth (thickness of film + thickness of backing material)

 ["Target blade depth" P.113](#)

- 3 Turn the adjustment knob clockwise to stick out the blade and adjust the blade depth.

### Important!

- One revolution of adjustment knob will stick out (or store) the blade 0.5 mm.
- Once adjusted, make sure not to turn the adjustment knob. This will change the blade depth.

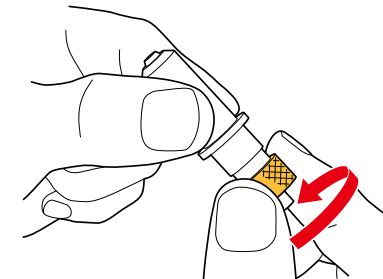

Before Use

Basic Operations

Cutting Workflow

Maintenance

When problems occur

Appendix

Cut Preparation

Print and cut separately

Print & Cut

Cut only

Optimize cut quality

## Install the blade holder into the machine

1 Open the front cover.

2 Raise the head adjustment lever to change the print head height to "High".

**Important!**

Make sure to set it to "High". The print head may contact the pinch roller arm and get damaged.

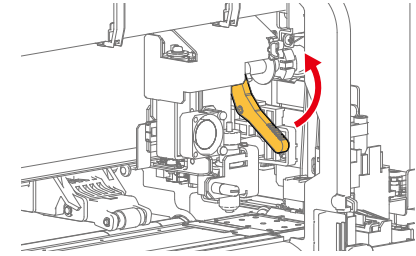

3 Push the carriage to unlock it.

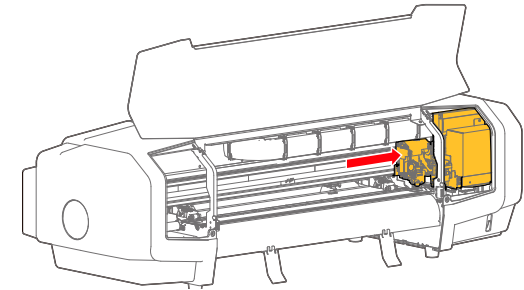

4 Manually move the carriage to the platen where you can easily install the blade holder.

**Important!**

Hold the print head adjustment lever to move it.

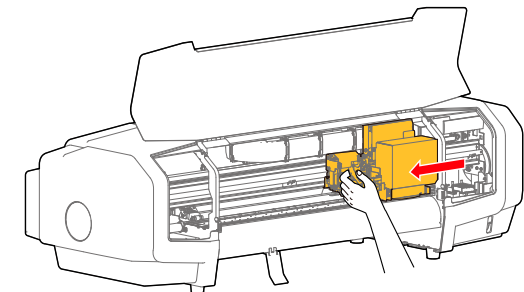

Before Use

Basic Operations

Cutting Workflow

Maintenance

When problems occur

Appendix

Cut Preparation

Print and cut separately

Print & Cut

Cut only

Optimize cut quality

## 5 Attach the blade holder.

1. Loosen the thumbscrew.
2. Open the holder fixing plate.

### Important!

Do not remove the thumbscrew from the holder fixing plate..

3. Fit the outer ring of the blade holder in the gap between A and B.

4. Close the holder fixing plate.

5. Tighten the thumbscrew.

### Important!

Insert the thumbscrew straight into the screw hole and tighten. If it is slanted, the screw may not be tightened properly, causing damage to the cutter and other part.

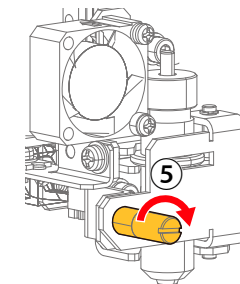
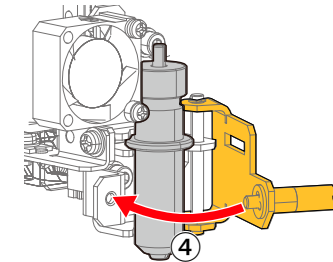
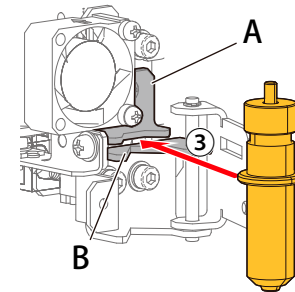
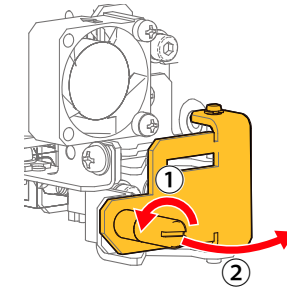

Before Use

Basic Operations

Cutting Workflow

Maintenance

When problems occur

Appendix

Cut Preparation

Print and cut separately

Print & Cut

Cut only

Optimize cut quality

6 Move the carriage back in place to lock it.

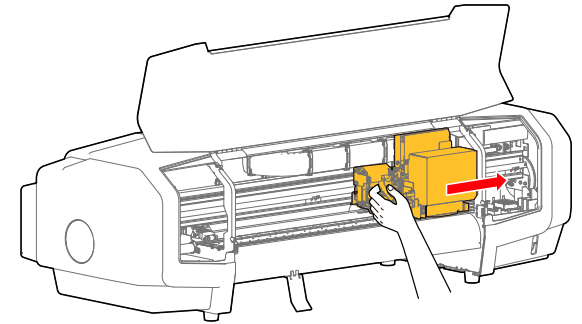

7 Lower the lever to change the head height to "Low".

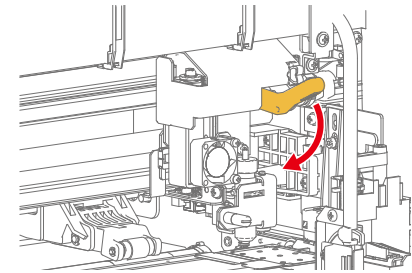

8 Close the front cover.

Before Use

Basic Operations

Cutting Workflow

Maintenance

When problems occur

Appendix

Cut Preparation

Print and cut separately

Print & Cut

Cut only

Optimize cut quality

## Run a test cut

To obtain good cutting results, run a test cut and adjust cutting parameters. Adjust these settings for media being used.

### Steps

- 1 Load media to be used for test cut.  
👉 "Loading media into the machine" P.51
- 2 Start MSM and open the remote panel.  
👉 "Launching/ Opening/Exiting MSM" P.26
- 3 Click the [Contour Cutting Settings] tab.

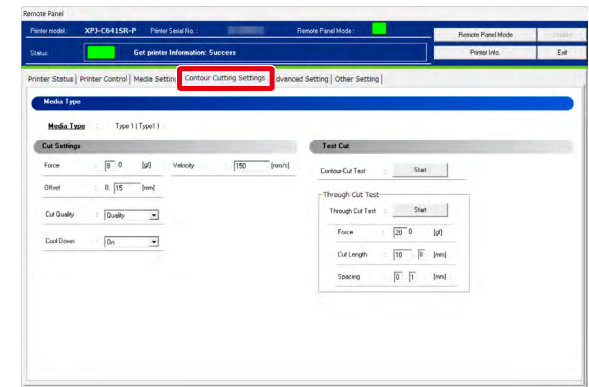

Before Use

Basic Operations

Cutting Workflow

Maintenance

When problems occur

Appendix

Cut Preparation

Print and cut separately

Print & Cut

Cut only

Optimize cut quality

4

Select the cutting method from [Test Cut] and run a test cut.

- "Test cut for contour cutting" P.120
- "Test cut for through cutting" P.123

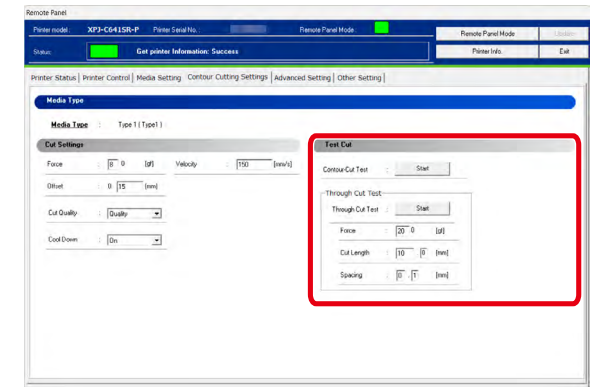

Before Use

Basic Operations

Cutting Workflow

Maintenance

When problems occur

Appendix

Cut Preparation

Print and cut separately

Print & Cut

Cut only

Optimize cut quality

## Test cut for contour cutting

### 1 Click [Start].

- The machine cuts the test cut pattern.

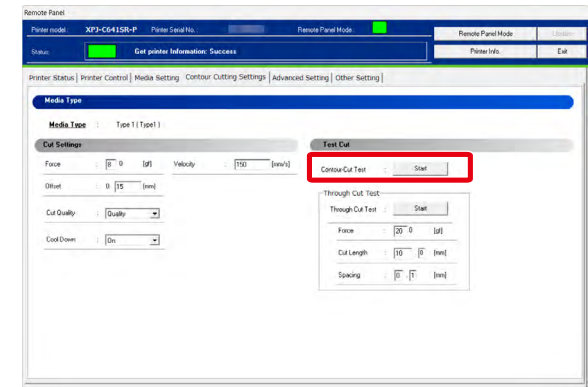

### 2 Examine the test cut result.

- A total of 5 patterns with the current cut force (marked with square) and  $\pm 40$ gf and  $\pm 20$ gf cut force will be cut. Check all of the 5 patterns of the test cut model to evaluate comprehensively.

1. Check the shape of square.
2. Remove a hexagon.
3. Remove a square.

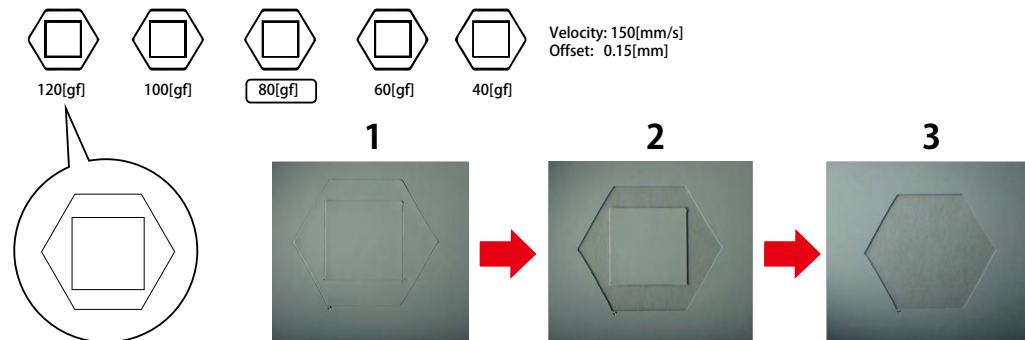



Before Use

Basic Operations

Cutting Workflow

Maintenance

When problems occur

Appendix

Cut Preparation

Print and cut separately

Print & Cut

Cut only

Optimize cut quality

3

Refer to the table below and enter the setting values in MSM as needed.

	Problems	How to calibrate	
1. Check the shape of square	Rounded corners	Offset	UP
	Corners with flags		DOWN
	Peeling on corners	Cut force	DOWN
2. Remove a hexagon	A hexagon is removed cleanly and a square is kept on the backing material.	Cut force	No adjustment required
	A hexagon is not partially removed.		UP
	A square is also removed together.		
3. Remove a square	A faint cut mark appears on the backing.	Cut force	No adjustment required
	No cut mark appears on the backing.		UP
	A deep cut mark appears on the backing or the backing was completely cut through.		DOWN

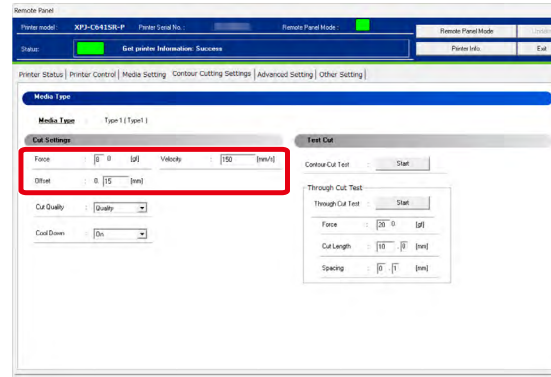

Before Use

Basic Operations

Cutting Workflow

Maintenance

When problems occur

Appendix

Cut Preparation

Print and cut separately

Print & Cut

Cut only

Optimize cut quality

4

Repeat a test cut and calibration until you get good results.

 **Note**

If peeling occurs when cutting the actual design, adjust the blade depth and cut force.

 ["Adjust blade depth" P.113](#)

	Problem	Blade depth
1. Check the shape of square	Peeling on corners	decrease
2. Remove a hexagon	A hexagon is not partially removed.	Increase
	A square is also removed together.	Increase
3. Remove a square	No cut mark appears on the backing.	Increase
	A deep cut mark appears on the backing or the backing was completely cut through.	decrease

 **Note**

The cutting conditions can be changed in VerteLith as well.

 ["Set cutting conditions" P.146](#)

Before Use

Basic Operations

Cutting Workflow

Maintenance

When problems occur

Appendix

Cut Preparation

Print and cut separately

Print & Cut

Cut only

Optimize cut quality

## Test cut for through cutting

1 Click [Start].

- The machine cuts the test cut pattern.

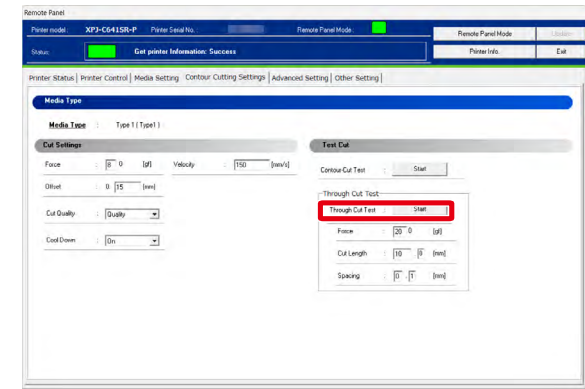

2 Examine the test cut result.

- A total of 5 patterns with the current cut force (marked with square) and  $\pm 40$ gf and  $\pm 20$ gf cut force will be cut.
- Check all of the 5 patterns to evaluate comprehensively.

1. Check the shape of square.
2. Pop out the square from the media.

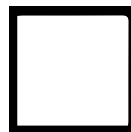

240[gf]

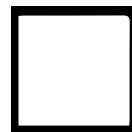

220[gf]

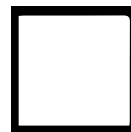

200[gf]



180[gf]

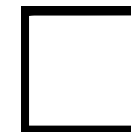

160[gf]

Length: 0.5 [mm]  
Spacing: 0.2 [mm]

Before Use

Basic Operations

Cutting Workflow

Maintenance

When problems occur

Appendix

Cut Preparation

Print and cut separately

Print & Cut

Cut only

Optimize cut quality

3

Refer to the table below and enter the setting values in MSM as needed.

	Problems	How to calibrate	
1. Check the shape of square	Rounded corners	Offset	UP
	Corners with flags		DOWN
	Peeling on corners		DOWN
2. Pop out the square from the media	Unable to pop it out	Cut force	DOWN
		Cut force	UP
		Cut length	UP
	Unable to remove backing material partially	Spacing	DOWN
		Cut force	UP
		Cut length	UP
	A square was released from the media during cutting	Spacing	DOWN
		Cut length	DOWN
		Spacing	UP

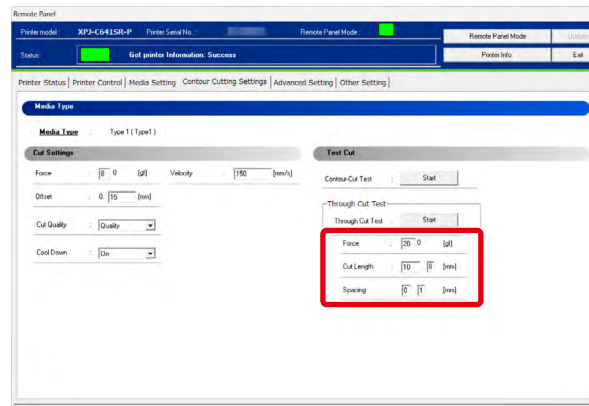

Before Use

Basic Operations

Cutting Workflow

Maintenance

When problems occur

Appendix

Cut Preparation

Print and cut separately

Print & Cut

Cut only

Optimize cut quality

4 Repeat a test cut and calibration until you get good results.

 **Note**

If you cannot pop out the design from media when cutting the actual design, adjust the blade depth.

 ["Adjust blade depth" P.113](#)

	Problem	Blade depth
Pop out the square from media	Unable to pop it out	Increase
	Unable to remove backing material partially	
	A square was released from the media during cutting	decrease

5 Determine the optimum settings and enter in VerteLith.

 ["Set cutting conditions" P.146](#)

 **Important!**

For through cut, the cut settings entered for test cut in MSM are not saved in VerteLith. Make sure to enter the settings in VerteLith.

Before Use

Basic Operations

Cutting Workflow

Maintenance

When problems occur

Appendix

Cut Preparation

Print and cut separately

Print & Cut

Cut only

Optimize cut quality

## Adjust the contour cutting position

Align the contour cutting with the printed object. Adjust it for media being used.

### Procedure

- 1 Load media.  
☞ "Loading media into the machine" P.51
- 2 Start MSM and open the remote panel.  
☞ "Launching/ Opening/Exiting MSM" P.26
- 3 Click the [Media Setting] tab.

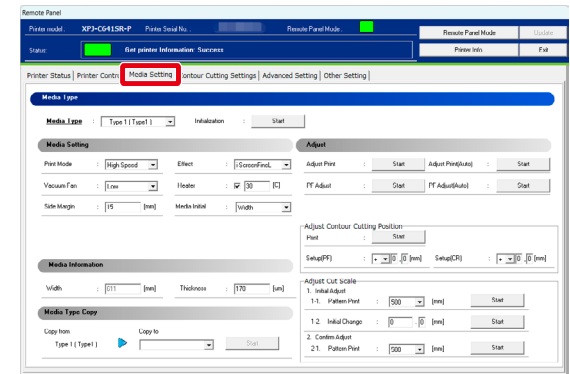

Before Use

Basic Operations

Cutting Workflow

Maintenance

When problems occur

Appendix

Cut Preparation

Print and cut separately

Print & Cut

Cut only

Optimize cut quality

4

From [Adjust] > [Adjust Contour Cutting] > [Print], click [Start].

- The machine begins printing a pattern.

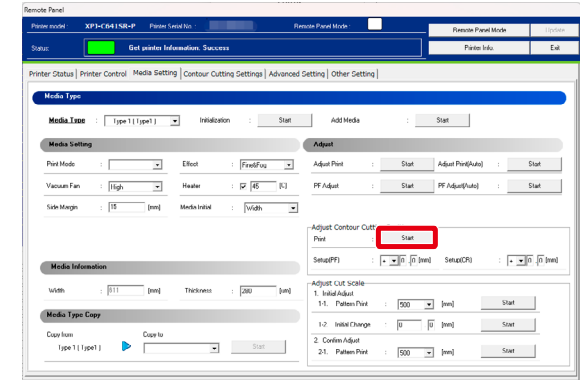

5

Check the cut line (red line) in the adjustment pattern.

- Measure the amount of misalignment between the cut line and the print line by eye. One scale in the adjustment pattern equals to 0.5 mm.
- In the example below, the red line is misaligned +1.0 mm in the PF (vertical) direction and +0.5mm in the CR (horizontal) direction.

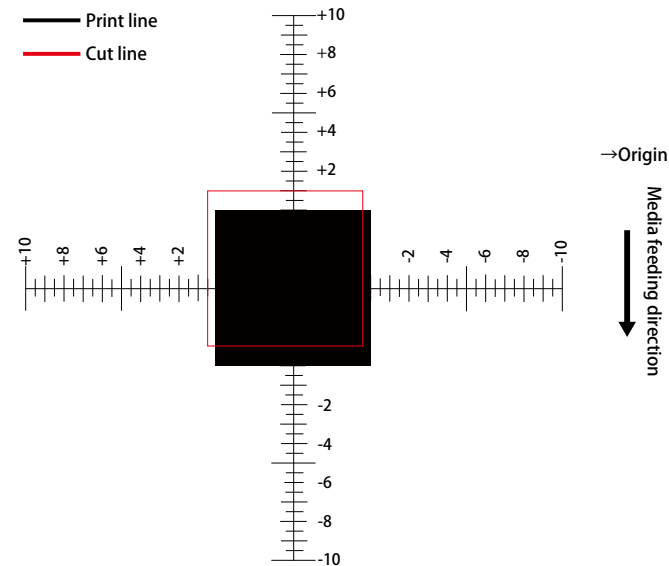

Before Use

Basic Operations

Cutting Workflow

Maintenance

When problems occur

Appendix

Cut Preparation

Print and cut separately

Print & Cut

Cut only

Optimize cut quality

6

Enter the measured length in the PF adjustment value and CR adjustment value respectively on MSM.

- In the example of step 5, you will enter PF **+1.0** (mm) and CR **+0.5** (mm).
- If an adjustment value is already entered, add the measured length to the adjustment value currently entered.

For example:

when PF: +0.3, CR: 0.2 are already entered, you will add the above PF: +1.0, CR: +0.5 to the current values so that the PF adjustment value will be **+1.3** (+0.3 + (+1.0)) and CR adjustment value will be **+0.3** (-0.2 + (+0.5)).

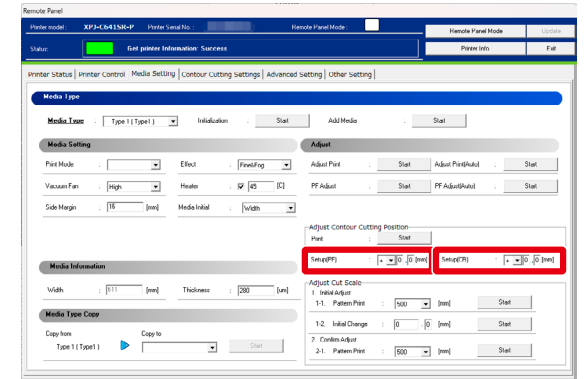



Before Use

Basic Operations

Cutting Workflow

Maintenance

When problems occur

Appendix

Cut Preparation

Print and cut separately

Print & Cut

Cut only

Optimize cut quality

## Cutting types

- Contour Cut : Cuts only the film (②) , not the backing material (①) .

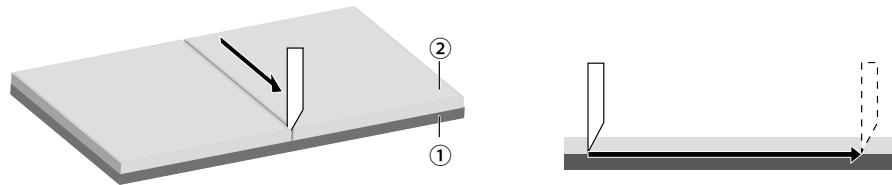

- Through Cut : Perf cuts through the film (②) and the backing material (①) so that some parts are not completely separated from the media. You can pop out each design with the backing after cutting.

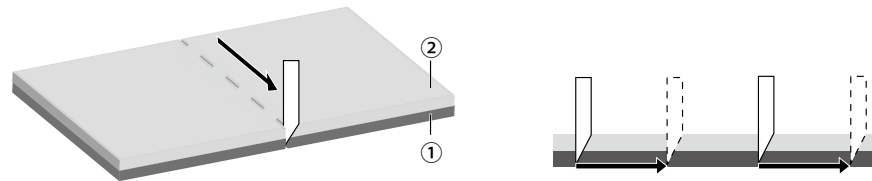

Cutting example

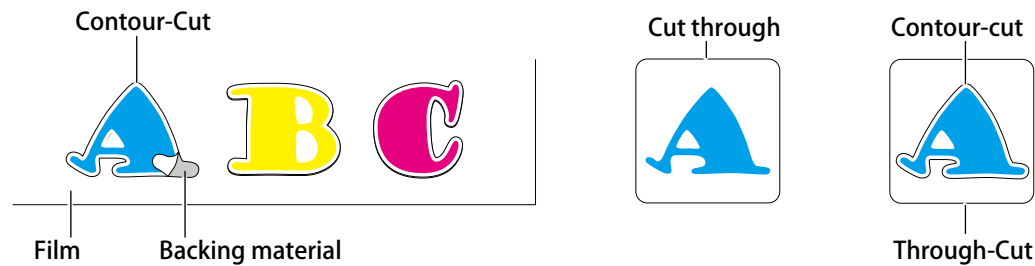

### Note

- Set the cutting conditions needed for media being used or required quality level.
- ☞ ["Set cutting conditions" P.146](#)
- The cutting mat and the edge of blade wear faster with through cut.

Before Use

Basic Operations

Cutting Workflow

Maintenance

When problems occur

Appendix

Cut Preparation

Print and cut separately

Print & Cut

Cut only

Optimize cut quality

## Create a cutting data

You will set the color defined as cutting line in VerteLith to the data.

The following is the color setting you will create a cutting data in Adobe Illustrator. Create a new swatch according to the cutting type.

### ● Contour cut

New swatch	
Name	CutContour
Color type	Spot color

### ● Through cut

New swatch	
Name	CutThrough
Color type	Spot color

CutContour (Contour cut)

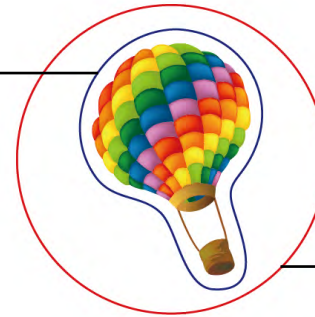

CutThrough (Through cut)

### Note

A file name such as "CutContour1", "CutThrough\_A" can be used.

Before Use

Basic Operations

Cutting Workflow

Maintenance

When problems occur

Appendix

Cut Preparation

Print and cut separately

Print & Cut

Cut only

Optimize cut quality

## Types of crop marks

To align the cut line with the printing position, you will need to add and print the crop marks around the graphic. When cutting, the sensor automatically detects the crop marks to align the position.

### 4-point positioning

This is used for standard cutting. 4-point positioning prints crop marks on four corners of the print data. The mark on the front right corner is the origin mark (①).

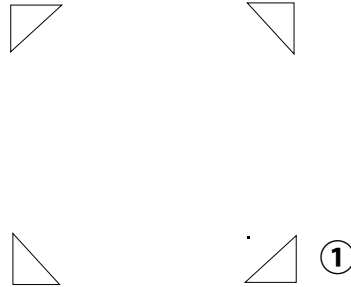

Before Use

Basic Operations

Cutting Workflow

Maintenance

When problems occur

Appendix

Cut Preparation

Print and cut separately

Print & Cut

Cut only

Optimize cut quality

## Media orientation auto-detection

Normally, media is loaded with origin crop mark positioned on the front right of the printer. Even if media is loaded upside down, the sensor reads the crop marks on four corners, automatically detects media loading direction, and then rotates the cutting data to cut it correctly.

### ● Mark detection order

The machine detects the crop marks from the front right corner in the counter clockwise direction.

- Media is loaded in the correct direction : ①→②→③→④ (A)
- Media is loaded upside down : ③→④→①→② (B)
- Media is loaded with 90-degree rotation (square media) : ④→①→②→③ (C) , ②→③→④→① (D)

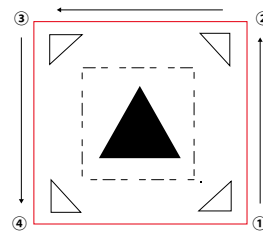

A

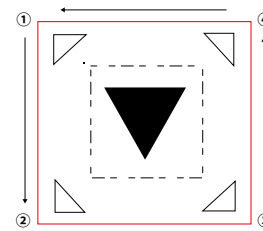

B

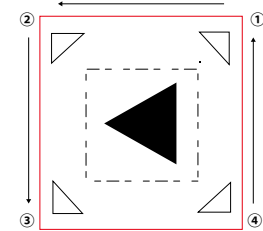

C

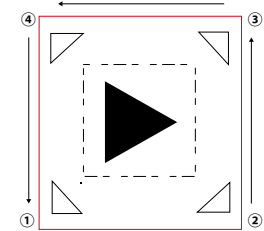

D

Before Use

Basic Operations

Cutting Workflow

Maintenance

When problems occur

Appendix

Cut Preparation

Print and cut separately

Print & Cut

Cut only

Optimize cut quality

# Print and cut separately

Use this procedure when you want to remove the media after printed, laminate it or do other treatment and reload the media for cutting. When reloading media, crop marks printed by VerteLith are used for alignment.

## Operation flow

### 1. Print a design with crop marks.

👉 "Step1. Print" P.134

### 2. Reload the media and perform cutting. (with reading crop marks)

👉 "Step2. Cut" P.140

## Required media size for automatic detection of crop marks

①	Pinch rollers
a	at least 40 mm
b	at least 80 mm
c (d*+e)	15 mm to 55 mm or more
d*	10mm / 25mm
e	at least 5 mm
f	at least 15mm

\*There are 2 types of crop marks.

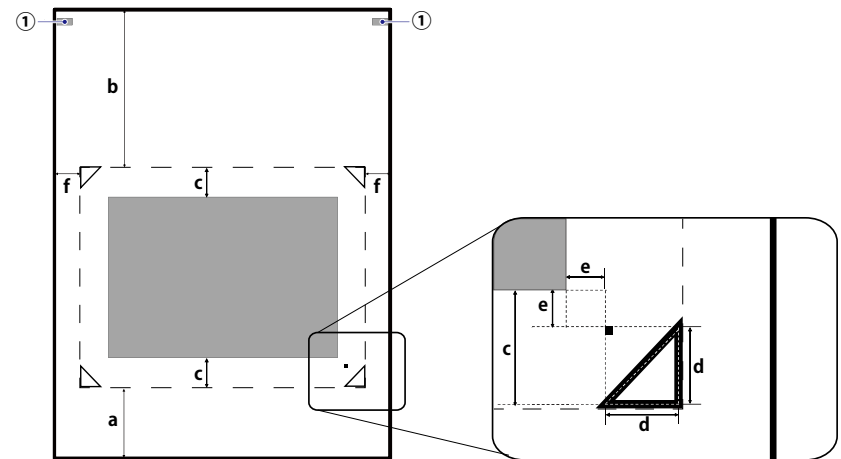

Before Use

Basic Operations

Cutting Workflow

Maintenance

When problems occur

Appendix

Cut Preparation

Print and cut separately

Print & Cut

Cut only

Optimize cut quality

## Step1. Print

### Important !!

メディアの送り方向に障害物を置かないでください。メディアの送りが妨げられると、印刷やカットの品質に悪影響があります。

- 1 Load media.  
☞ "Loading media into the machine" P.51
- 2 Start VerteLith.  
☞ "Launching VerteLith" P.36
- 3 Click [Add Job] ( ① ).  
Select the printer and the print environment you will add a job and click [OK] ( ② ) .

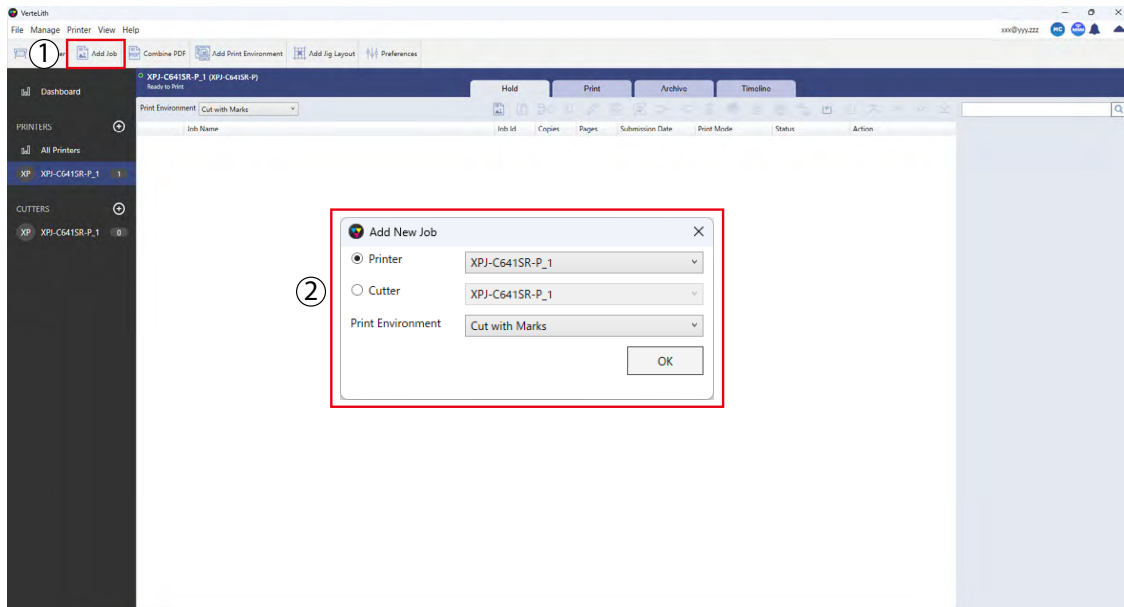

Before Use

Basic Operations

Cutting Workflow

Maintenance

When problems occur

Appendix

Cut Preparation

Print and cut separately

Print & Cut

Cut only

Optimize cut quality

4 Select a data containing cut lines ( ① ) and click [Open] ( ② ).  
"Create a cutting data" P.130

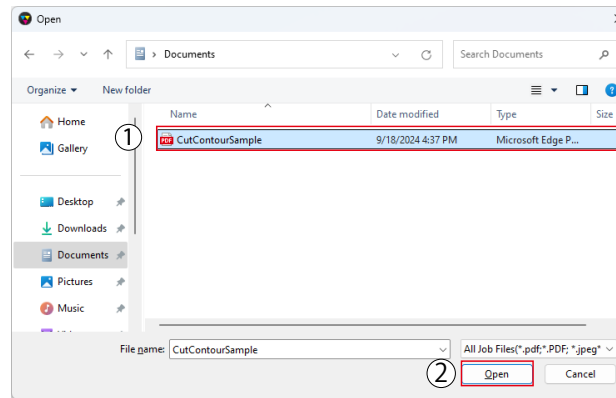

5 Select the job added ( ① ) and click [Edit job] ( ② ).

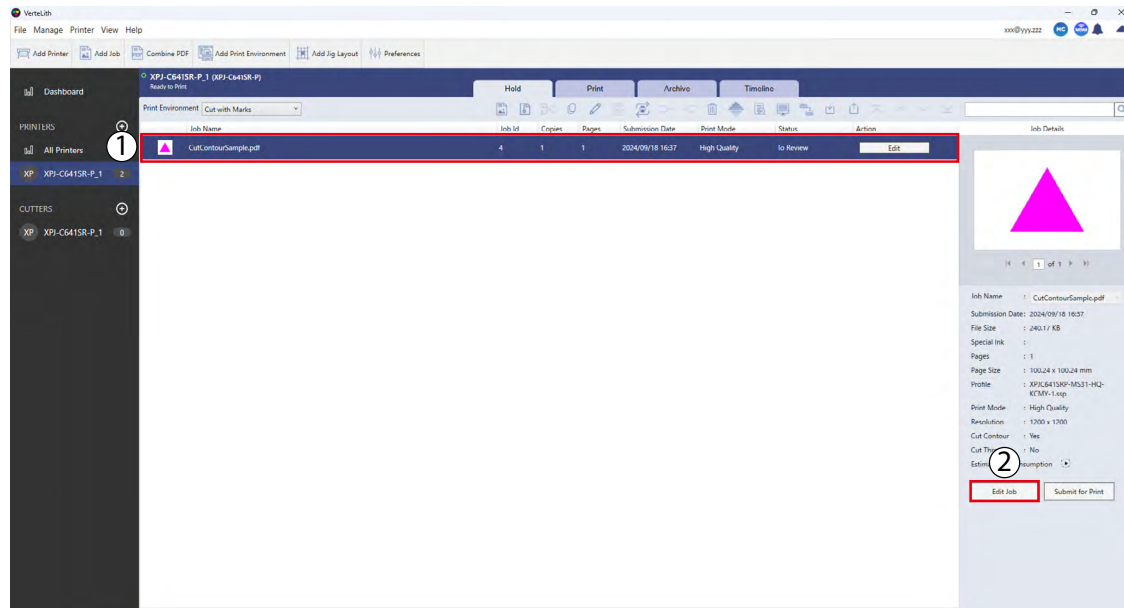

Before Use

Basic Operations

Cutting Workflow

Maintenance

When problems occur

Appendix

Cut Preparation

Print and cut separately

Print & Cut

Cut only

Optimize cut quality

6

In the General tab, deselect the checkbox "Cut continuously after printing".

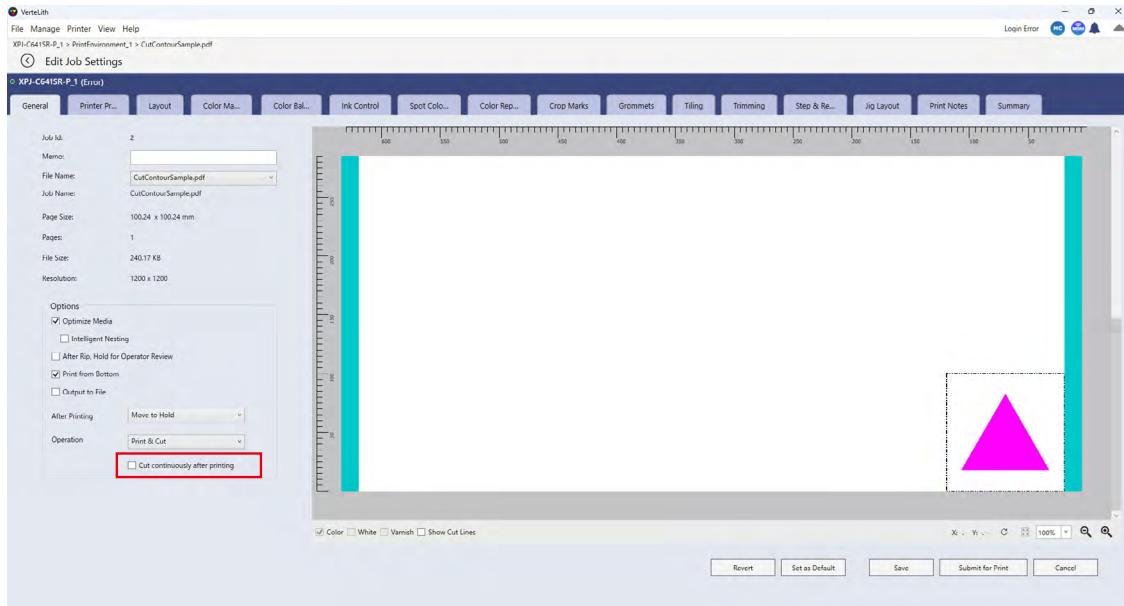



Before Use

Basic Operations

Cutting Workflow

Maintenance

When problems occur

Appendix

Cut Preparation

Print and cut separately

Print & Cut

Cut only

Optimize cut quality

## 7 Set the crop marks.

- Click [Crop Marks] tab (①) .
- Select the "Enable Crop Marks" checkbox and the "Crop Marks for Cut Devices" checkbox (②) .
- Select a mark from the Mark Type option (③) .
- Select the checkbox "Advance feed after print" and enter the required margin (more than 80 mm) (④).\*1
- Click [Save] (⑤) .

### Important!

\*1 "Required media size for automatic detection of crop marks" P.133

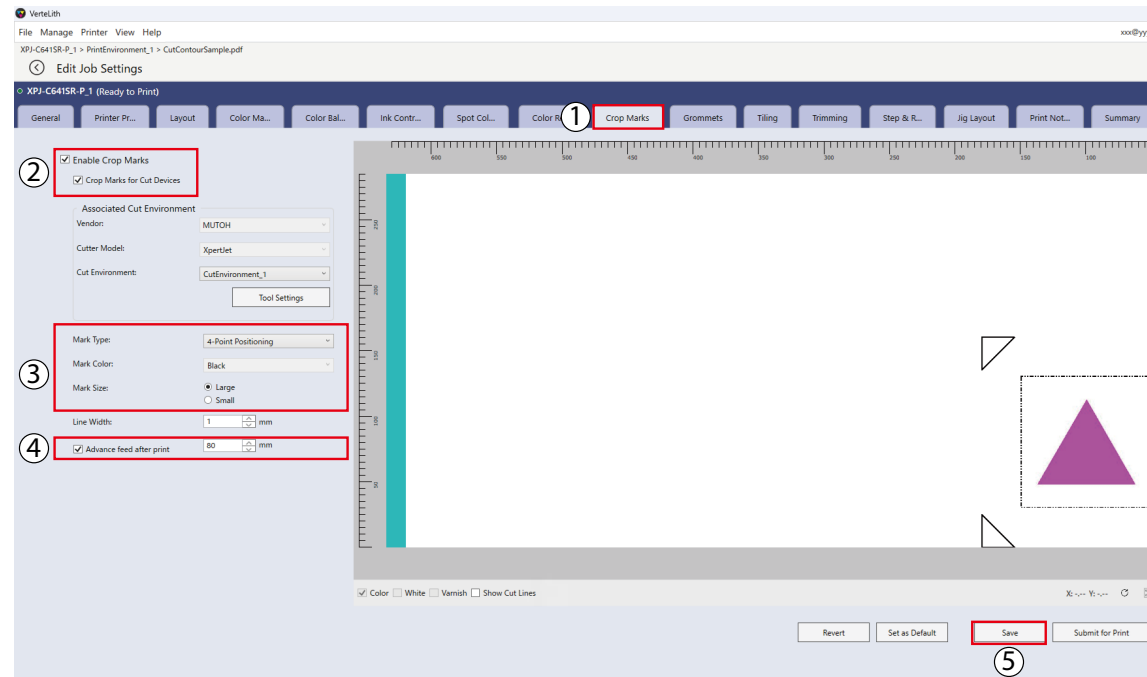

Before Use

Basic Operations

Cutting Workflow

Maintenance

When problems occur

Appendix

Cut Preparation

Print and cut separately

Print & Cut

Cut only

Optimize cut quality

8

Select the job added to the printer ( ① ) and click [Submit for Print] ( ② ).

- The job moves to the Print queue and printing begins.
- The job automatically moves to the Hold queue after printing.

 **Note**

To change the print settings, click [Edit Job].

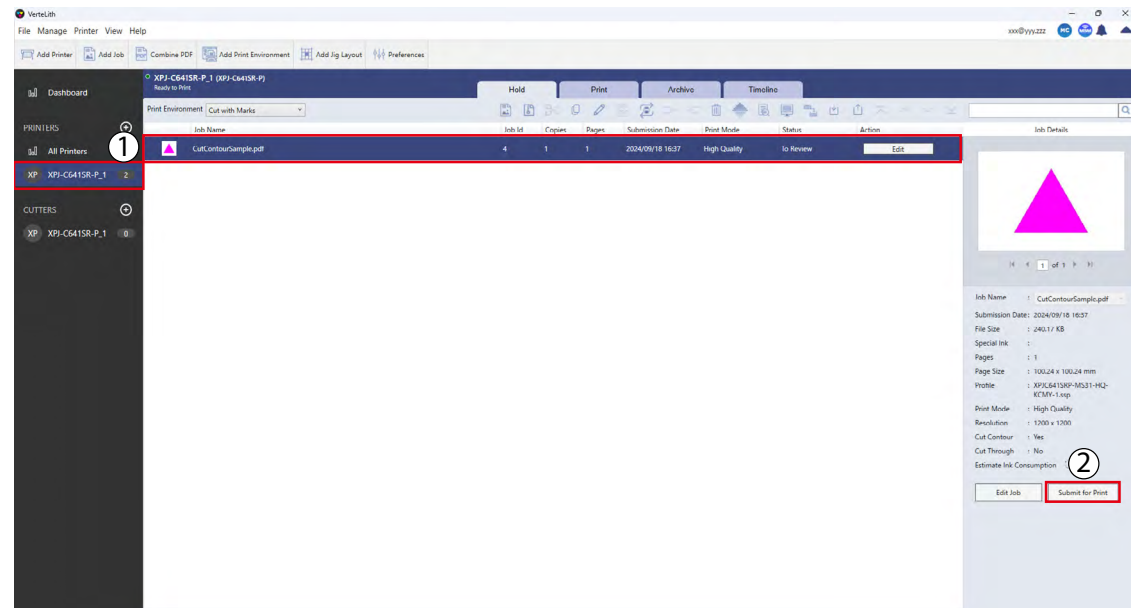

Example of image printed with crop marks

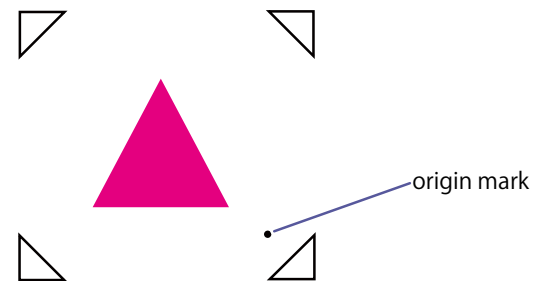

Before Use

Basic Operations

Cutting Workflow

Maintenance

When problems occur

Appendix

Cut Preparation

Print and cut separately

Print & Cut

Cut only

Optimize cut quality

9

Cut the sheet off the roll media.

 ["Cut the media" P.89](#)

 **Important !**

At least 80 mm of blank space from the bottom edge of the crop mark is required.

 ["Required media size for automatic detection of crop marks" P.133](#)

Before Use

Basic Operations

Cutting Workflow

Maintenance

When problems occur

Appendix

Cut Preparation

Print and cut separately

Print & Cut

Cut only

Optimize cut quality

## Step2. Cut

### Important!

- In MSM, configure the Media Initial and Heater settings as follows:
  - Media Initial: "Width" or "Off"
  - Heater: "Off"
- In the following cases, the machine cannot read the crop marks:
  - ① Crop marks printed on colored media.
  - ② The media surface has dirt.
  - ③ The media has wrinkles.

### 1 Load the media printed with crop marks into the machine.

- Media is loaded with origin crop mark positioned on the front right of the printer. Load it so that the bottom edges of the two crop marks on the media are aligned horizontally on the cutting mat (②).
- The media should not be skewed more than five degrees.

#### Good

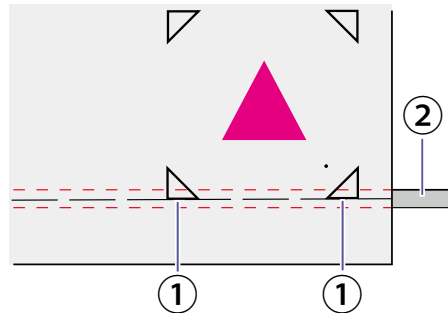

#### Not Good

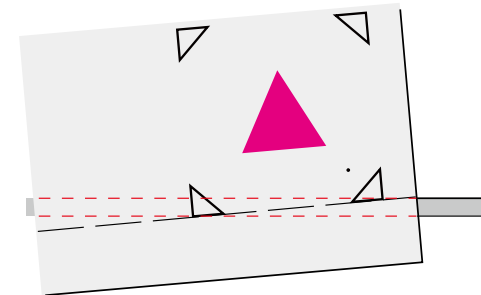

### Note

Even if media is loaded upside down, the machine can perform cutting correctly.

👉 ["Media orientation auto-detection" P.132](#)

Before Use

Basic Operations

Cutting Workflow

Maintenance

When problems occur

Appendix

Cut Preparation

Print and cut separately

Print & Cut

Cut only

Optimize cut quality

2

Select a cutter (①) . Select a cut environment (②) and a cutting job (③) , and click [Submit for Cut] (④) .

- The sensor reads the crop marks and cutting begins.
- The job automatically moves to the Hold queue of the print environment after cutting.

### Important!

When the machine failed to read the cropmarks, the error LED will turn on. Follow these steps to address the problem.

1. Check the error details in [Status Information] on MSM.

☞ "Check the message/ error/ warning" P.220

2. Follow an appropriate instruction depending on the error type.

☞ "Crop mark read error(Media set error)" P.226

☞ "Crop mark read error(Media Skew Error)" P.226

☞ "Crop mark read error(Mark \* read error)" P.226

### Note

To change the cutting conditions, click [Edit Job].

☞ "Set cutting conditions" P.146

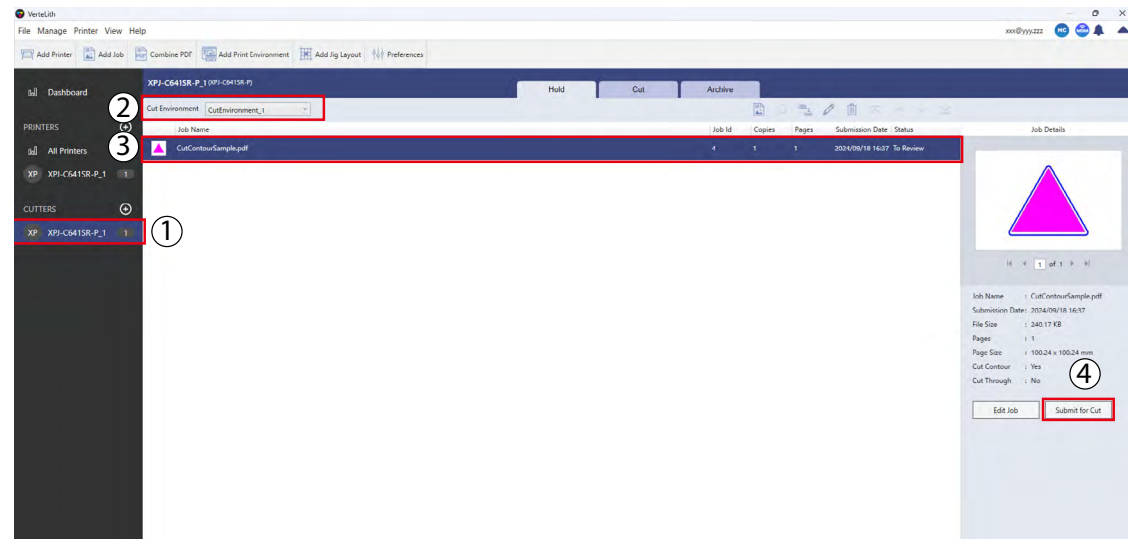

Before Use

Basic Operations

Cutting Workflow

Maintenance

When problems occur

Appendix

Cut Preparation

Print and cut separately

Print & Cut

Cut only

Optimize cut quality

# Print & Cut

Print and Cut performs printing followed by cutting. You will need output data for both printing and cutting.

## Important!

For Print and Cut method, please note the following points:

- Make sure to completely dry your print before performing cutting. You can specify the time interval (for ink drying) in MSM. An appropriate drying time varies by types of media.
  - ☞ "Specify the ink drying time" P.105
- Leaving media warm by the heater will cause poor cutting quality. The Cool Down menu allows the machine to wait until the heater is cooled down before cutting.
  - ☞ "Cooling down setting" P.103
- Do not place any objects on the media feeding direction. If media feeding is interrupted, this will affect printing or cutting quality.

- 1 • Follow the step 1 "Print" in "Print and cut separately" to print a job.
  - ☞ "Step1. Print" P.134
- In the [General] tab, select the "Cut continuously after printing" checkbox.

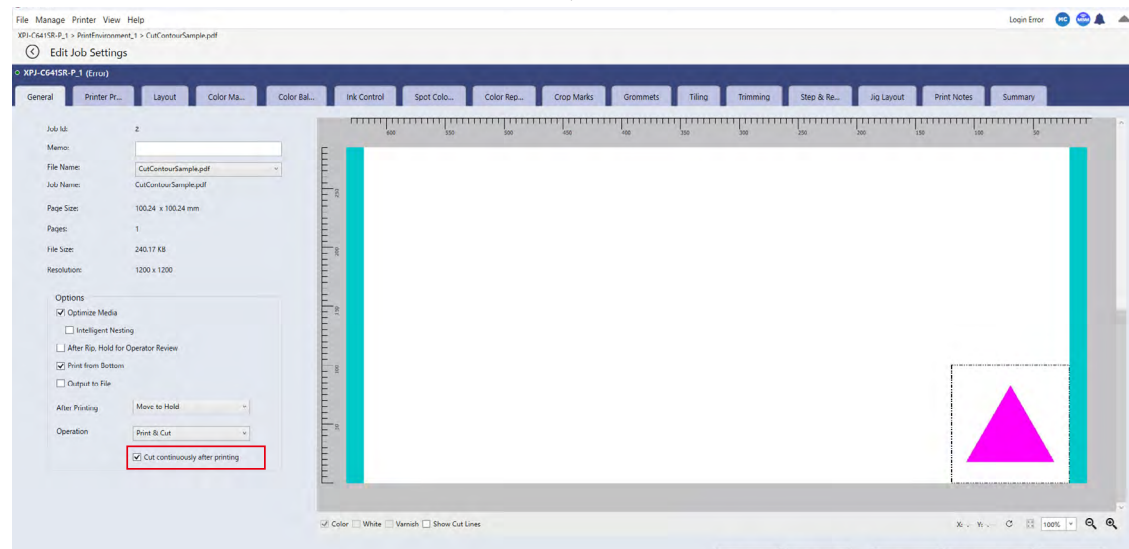

Before Use

Basic Operations

Cutting Workflow

Maintenance

When problems occur

Appendix

Cut Preparation

Print and cut separately

Print & Cut

Cut only

Optimize cut quality

### Note

For print and cut, cutting can also be performed without crop marks.

2 Select the job added (①) and click [Submit for Print] (②) .

- The job sent to the machine moves to the Print queue and printing begins.
- The job moves to the Cut queue after printing.
- After cutting is complete, the job moves to the Hold queue.

### Note

To change the cutting conditions, click [Edit Job].

☞ "Set cutting conditions" P.146

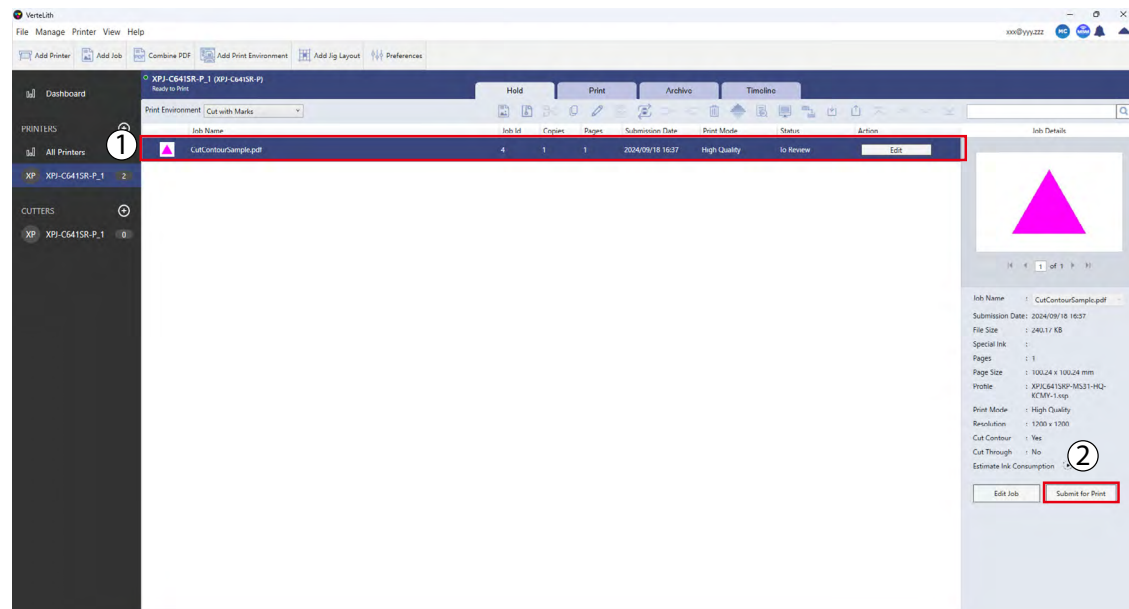

Before Use

Basic Operations

Cutting Workflow

Maintenance

When problems occur

Appendix

Cut Preparation

Print and cut separately

Print & Cut

Cut only

Optimize cut quality

# Cut only

## Important!

- Set the heater to [Off].
- Do not place any objects on the media feeding direction. If media feeding is interrupted, this will affect printing or cutting quality.

1 Load media.  
👉 "Loading media into the machine" P.51

2 Start VerteLith.  
👉 "Launching VerteLith" P.36

3 Click [Add Job] (①) .  
Select the cutter and cut environment to which the job is added and click [OK] (②) .

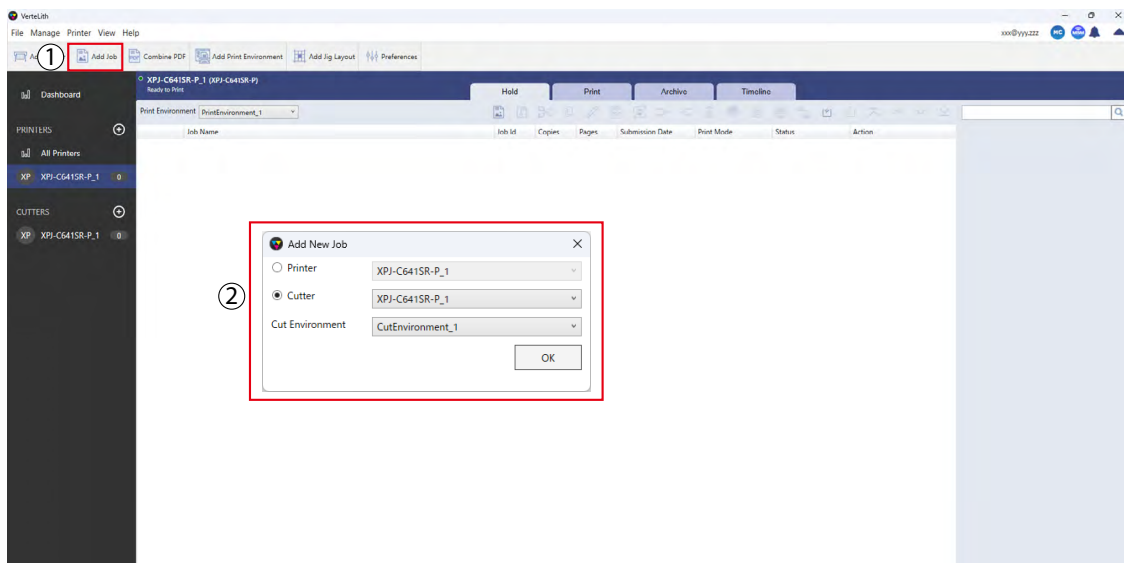



Before Use

Basic Operations

Cutting Workflow

Maintenance

When problems occur

Appendix

Cut Preparation

Print and cut separately

Print & Cut

Cut only

Optimize cut quality

4

Select a data containing cut lines ( ① ) and click [Open] ( ② ).

☞ "Create a cutting data" P.130

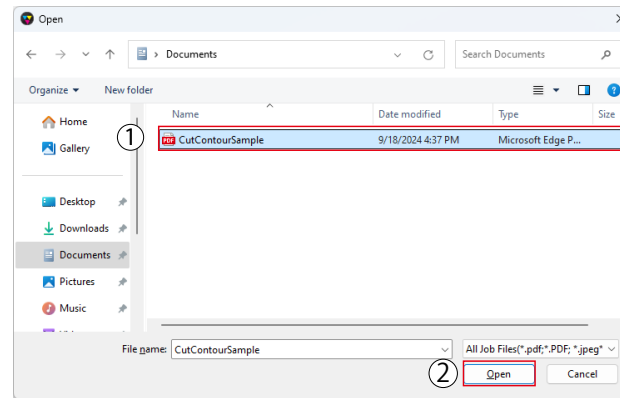

5

Select a cutter ( ① ). Select a cutting job ( ② ) and click [Submit for Cut] ( ③ ).

- The job sent to the machine moves to the Cut queue and cutting begins.
- The job automatically moves to the Hold queue after cutting.

 **Note**

To change the cutting settings, click [Edit Job].

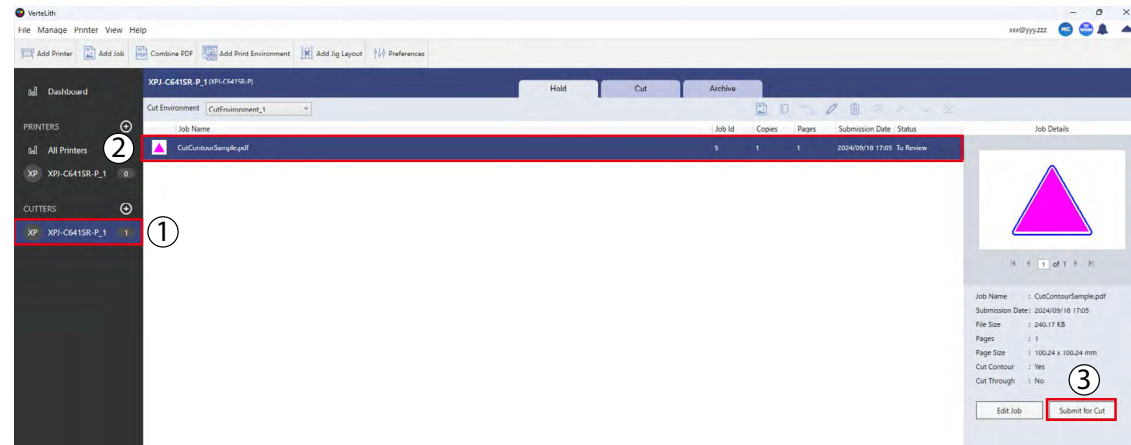

Before Use

Basic Operations

Cutting Workflow

Maintenance

When problems occur

Appendix

Cut Preparation

Print and cut separately

Print & Cut

Cut only

Optimize cut quality

# Optimize cut quality

Cutting conditions can be set in detail according to the media being used or cutting shape. Before cutting, run a test cut and adjust cutting conditions several times to find the optimal settings.

## Set cutting conditions

### Procedure

1 Run a test cut and examine the test cut result.  
👉 "Run a test cut" P.118

2 Select a job ( ① ) and click [Job Edit] ( ② ).

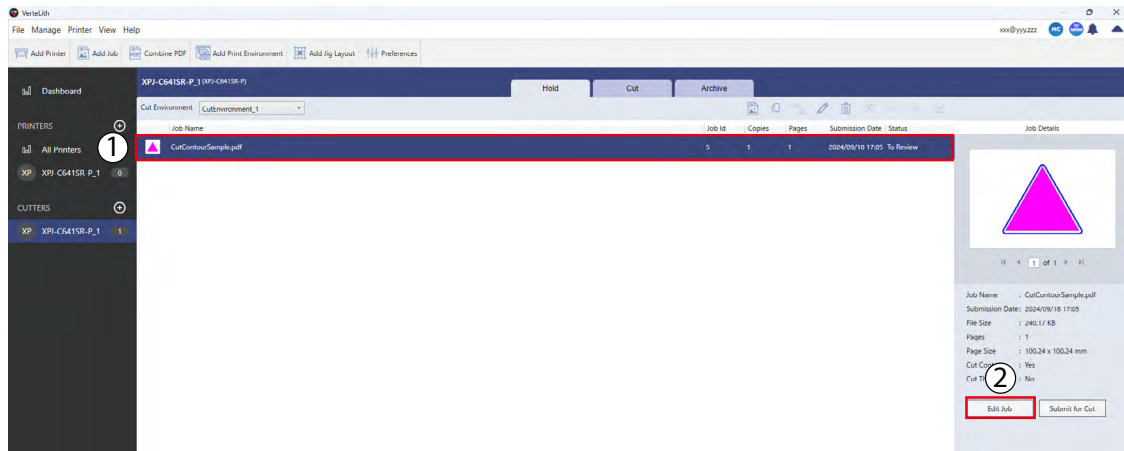

Before Use

Basic Operations

Cutting Workflow

Maintenance

When problems occur

Appendix

Cut Preparation

Print and cut separately

Print & Cut

Cut only

Optimize cut quality

3

- Click the Crop Marks tab ( ① ).
- Select [Enable Crop Marks] and [Crop Marks for Cut Devices] checkboxes ( ② ).
- Click [Tool Settings] ( ③ ).

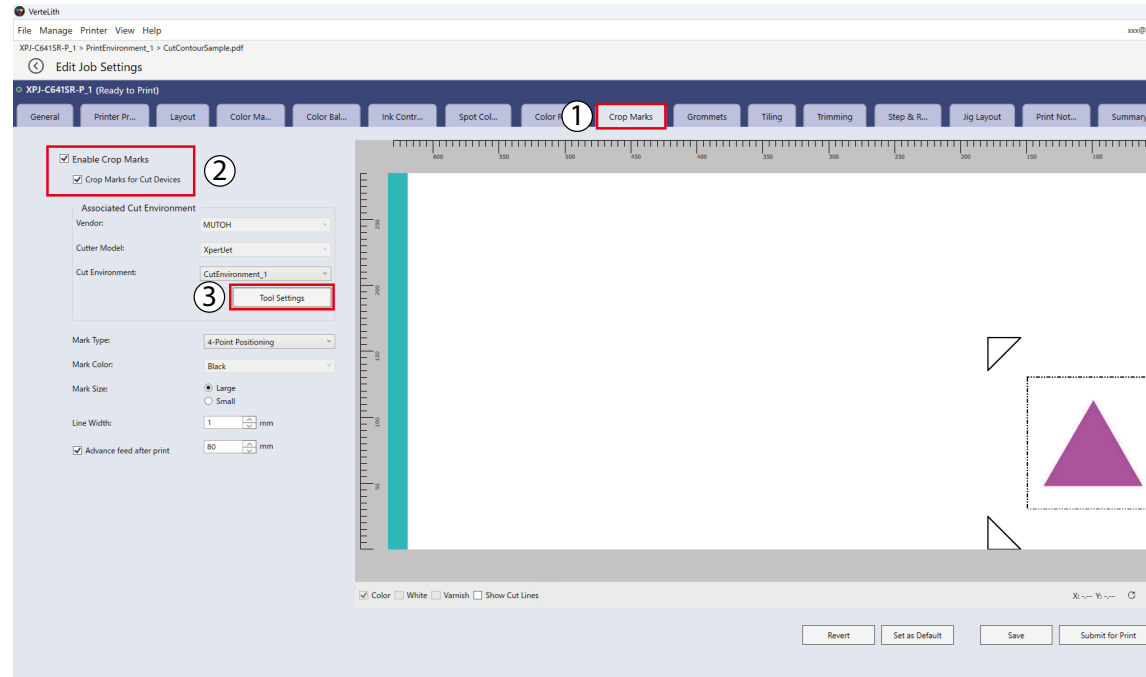

Before Use

Basic Operations

Cutting Workflow

Maintenance

When problems occur

Appendix

Cut Preparation

Print and cut separately

Print & Cut

Cut only

Optimize cut quality

4

Select the items you want to change and enter the value.

☞ "Cutting conditions" P.149

- ① Cut Contour: Setting items for contour cutting
- ② Cut Through: Setting items for through cutting

The screenshot shows the 'Tool Settings' dialog box with two sections highlighted by red boxes and numbered 1 and 2. Section 1, 'Cut Contour', includes: Cut Force (80 gf), Cut Acceleration (0.05 G), Cut Speed (150 mm/s), Blade Offset (0.15 mm), and Cut Count (1). Section 2, 'Cut Through', includes: Cut Force (200 gf), Cut Acceleration (0.05 G), Cut Speed (150 mm/s), Blade Offset (0.15 mm), Cut Count (1), Cutting length (10 mm), and Spacing (0.1 mm). 'Save' and 'Cancel' buttons are at the bottom.

Section	Item	Value	Unit
① Cut Contour	Cut Force	80	gf
	Cut Acceleration	0.05	G
	Cut Speed	150	mm/s
	Blade Offset	0.15	mm
	Cut Count	1	
② Cut Through	Cut Force	200	gf
	Cut Acceleration	0.05	G
	Cut Speed	150	mm/s
	Blade Offset	0.15	mm
	Cut Count	1	
	Cutting length	10	mm
	Spacing	0.1	mm

The values shown in this image are the default values.

Before Use

Basic Operations

Cutting Workflow

Maintenance

When problems occur

Appendix

Cut Preparation

Print and cut separately

Print & Cut

Cut only

Optimize cut quality

### ● Cutting conditions

Setting items	Setting range	Contents
Cut Force [gf]	30-300	The pressure that the blade comes down onto media. <ul style="list-style-type: none"><li>• Contour cut: Too much pressure will leave the blade holder marks on the media or cut through the backing material.</li><li>• Through cut: Too much pressure will shorten the life of the blade.</li></ul>
Cut Acceleration [G]	0.05-0.50	Cutter acceleration. If it is too large, the cut line is misaligned or gets crooked. The smaller the acceleration, the higher the accuracy.
Cut Speed [mm/s]	20-150	Moving speed of the cutter for cutting. If it is too high, the cut line is misaligned or gets crooked. The slower speed will improve accuracy.
Blade Offset [mm]	0-0.5	The distance between the center of the blade holder and the tip of blade. The following problems can be seen if this option is not set properly. <ul style="list-style-type: none"><li>- Peeling on corners -&gt; improper value</li><li>- Corners with flags -&gt; too large</li><li>- Rounded corner -&gt; too small</li></ul>
Cut Count	1-9	The number of times the blade cuts the same location. It may be effective to increase the number of cuts depending on the thickness or hardness of media.
Cutting length [mm]	0.1-100.0	(Through-cut only) Length of the area to be cut through.
Spacing [mm]	0.1-10.0	(Through cut only) Length of uncut area.

#### Important!

- The faster the "cut speed" and "cut acceleration", the worse the cutting quality. Adjust these settings according to the required cut quality level.
- Even if cutting condition is adjusted, using improper media could shorten the life of cutter or result in damage to the cutter.

 ["Media Size" P.39](#)

Before Use

Basic Operations

Cutting Workflow

Maintenance

When problems occur

Appendix

Cut Preparation

Print and cut separately

Print & Cut

Cut only

Optimize cut quality

5 Click [Save].

The screenshot shows a 'Tool Settings' dialog box with two sections: 'Cut Contour' and 'Cut Through'. Each section contains several settings with checkboxes and numerical input fields with up/down arrows. The 'Save' button at the bottom is highlighted with a red rectangle.

Section	Parameter	Value	Unit
Cut Contour	<input checked="" type="checkbox"/> Cut Force	80	gf
	<input checked="" type="checkbox"/> Cut Acceleration	0.05	G
	<input checked="" type="checkbox"/> Cut Speed	150	mm/s
	<input checked="" type="checkbox"/> Blade Offset	0.15	mm
	Cut Count	1	
Cut Through	<input checked="" type="checkbox"/> Cut Force	200	gf
	<input checked="" type="checkbox"/> Cut Acceleration	0.05	G
	<input checked="" type="checkbox"/> Cut Speed	150	mm/s
	<input checked="" type="checkbox"/> Blade Offset	0.15	mm
	Cut Count	1	
	Cutting length	10	mm
Spacing	0.1	mm	

Before Use

Basic Operations

Cutting Workflow

Maintenance

When problems occur

Appendix

Cut Preparation

Print and cut separately

Print & Cut

Cut only

Optimize cut quality

## Cut quality of curves

Cutting conditions for curved line can be selected from the following three modes. Select an appropriate one according to the sharpness and amount of curved lines contained in the cut data or required quality level.

Quality	Select this for cut data with many sharp curves and when you want to prioritize curve cutting quality over the speed.
Production	Select this for cut data with many gentle curves and when you want to balance between cutting quality and speed.
High Speed	Select this for cut data consisting of mostly straight lines or when you prioritize the speed over cutting quality.

### Note

There may be no difference in overall cutting speed depending on the sharpness or amount of curves included in cut data.

## Procedure

- 1 Start MSM and open the remote panel.  
 ["Displaying remote panel" P.27](#)
- 2 Click the [Contour Cutting Setting] tab.

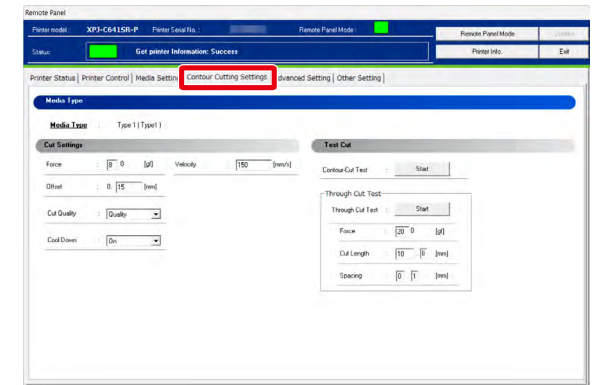

Before Use

Basic Operations

Cutting Workflow

Maintenance

When problems occur

Appendix

Cut Preparation

Print and cut separately

Print & Cut

Cut only

Optimize cut quality

3

Select the cutting mode from Quality, Production or High Speed in [Cut Quality].

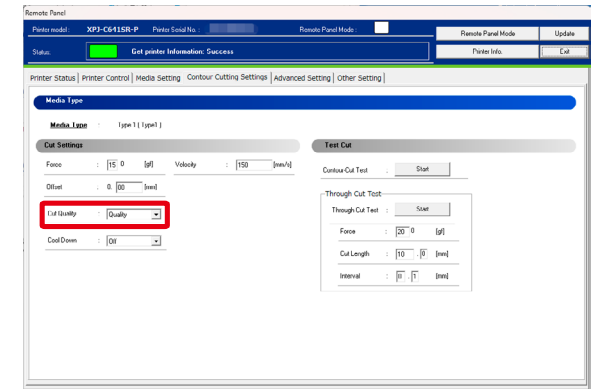

4

Click [Update].

- The change made is saved in the machine.

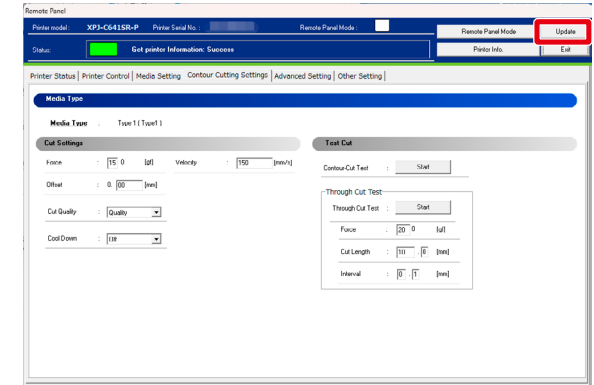



Before Use

Basic Operations

Cutting Workflow

Maintenance

When problems occur

Appendix

Cut Preparation

Print and cut separately

Print & Cut

Cut only

Optimize cut quality

## Cut scale adjustment

Calibrate the cutting distance in the carriage moving direction. This calibration should be performed when the following symptom appears:

- The cut position and print position do not match on the non-origin side.

### Procedure

#### 1. Initial Adjustment

- 1 Load media into the machine.  
👉 "Loading media into the machine" P.51
- 2 Start MSM and open the remote panel.  
👉 "Displaying remote panel" P.27
- 3 Click the Media Setting tab.

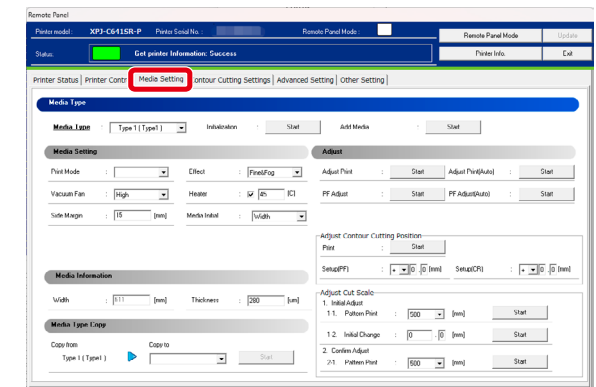

Before Use

Basic Operations

Cutting Workflow

Maintenance

When problems occur

Appendix

Cut Preparation

Print and cut separately

Print & Cut

Cut only

Optimize cut quality

**4** From [Adjust Cut Scale] > [1. Initial Adjust] > [1-1. Pattern Print], enter the width (mm) of the pattern to be printed and click [Start].

- The pattern printing and cutting with the specified width begins.

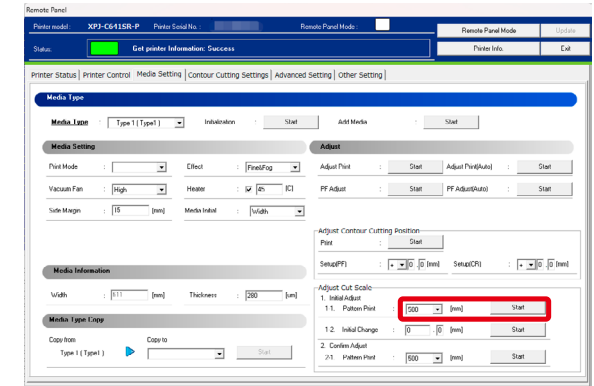

**5** Using the stepped scale lines printed on the left side of the pattern, measure the distance (④) between the reference line (③) and the cut line (B).

(Width of stepped scale line: One step = 0.1 mm)

- Print line: ①
- Cut line: ②

(In this illustration, the reference line is shown in red, but it will be printed in black.)

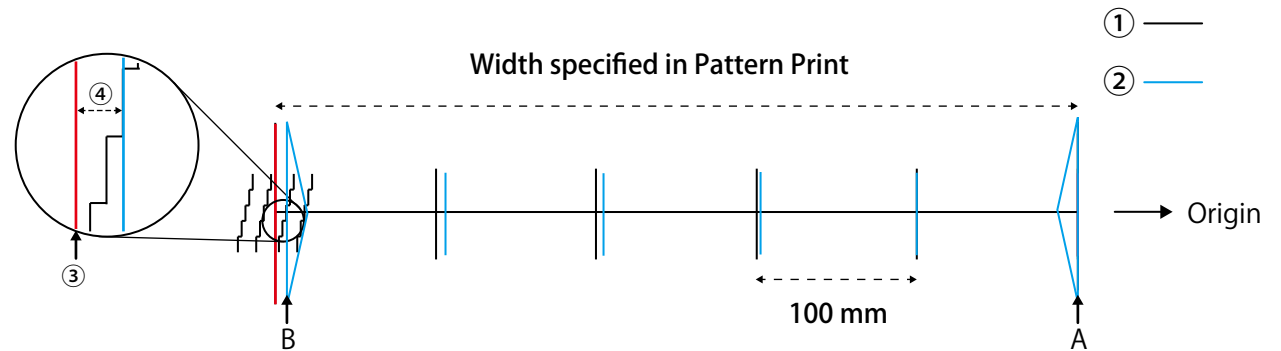

**Important!**

If the printed line and cut line do not align on the origin side (A), go to "**Adjust the contour cutting position**" P.126 to adjust contour cutting position.

Before Use

Basic Operations

Cutting Workflow

Maintenance

When problems occur

Appendix

Cut Preparation

Print and cut separately

Print & Cut

Cut only

Optimize cut quality

**6** The Initial Change value is calculated as [width (mm) of pattern] + [distance between the reference line and cut line (④ = the number of vertical lines in the scale lines x 0.1 mm)].

Example a) If the width of the pattern is set to 500 mm and the cut line was off from the reference line by five vertical lines of the scale lines to the origin side:

$$\textcircled{4} = 5 \times 0.1 \text{ mm} = -0.5 \text{ mm}$$

$$\text{Initial Change value} = 500 \text{ mm} - 0.5 \text{ mm} = 499.5 \text{ mm}$$

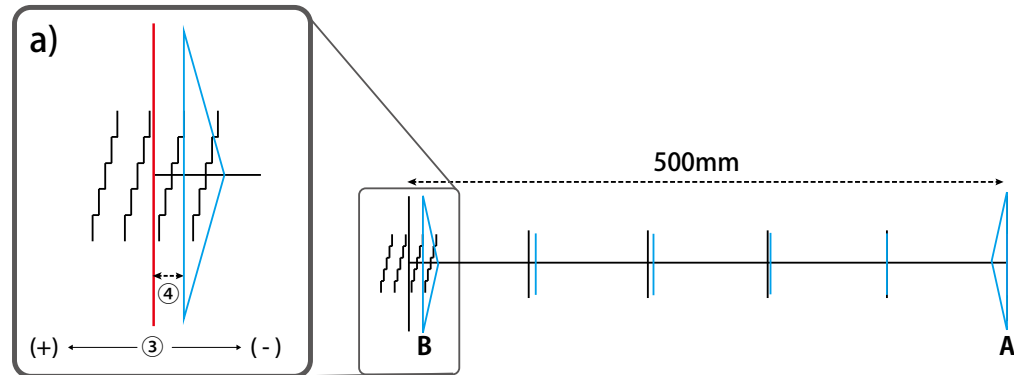

Example b) If the width of the pattern is set to 500 mm and the cut line was off from the reference line by eight vertical lines of the scale lines to the non-origin side:

$$\textcircled{4} = 8 \times 0.1 \text{ mm} = 0.8 \text{ mm}$$

$$\text{Initial Change value} = 500 \text{ mm} + 0.8 \text{ mm} = 500.8 \text{ mm}$$

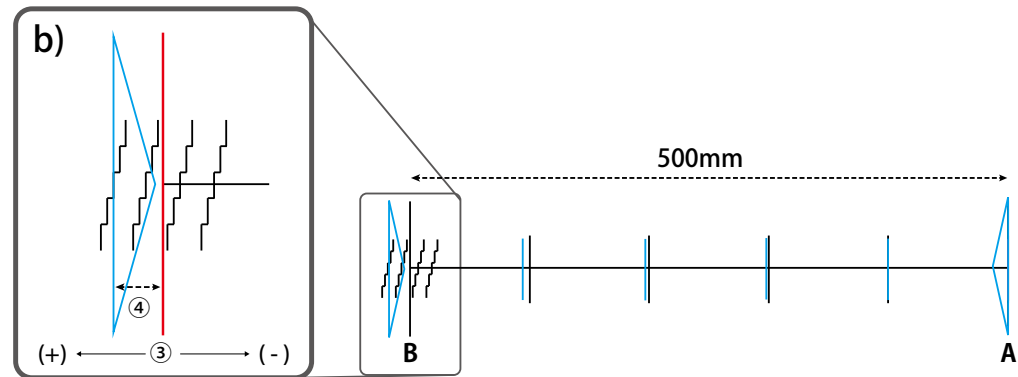

Before Use

Basic Operations

Cutting Workflow

Maintenance

When problems occur

Appendix

Cut Preparation

Print and cut separately

Print & Cut

Cut only

Optimize cut quality

## 7 Enter the Initial Change value (mm) in [1-2. Initial Change] and click [Start].

- The initial change value is saved in the machine.
- Next, move to **"2. Confirm Adjustment" P.156**

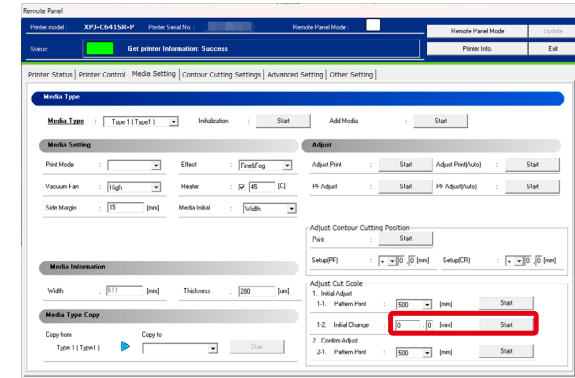

## 2. Confirm Adjustment

### 1 From [Adjust Cut Scale] > [2. Confirm Adjust] > [2-1. Pattern Print], enter the width (mm) of the pattern to be printed and click [Start].

- The pattern printing and cutting with the specified width begins.

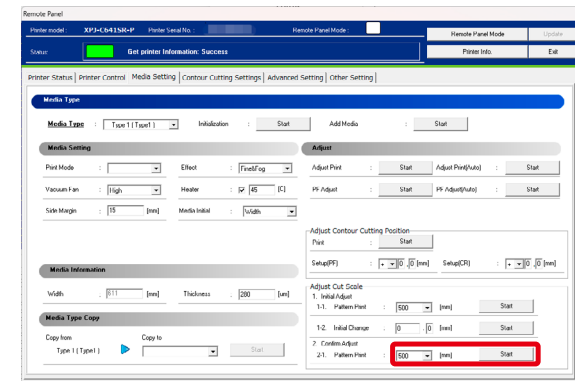

Before Use

Basic Operations

Cutting Workflow

Maintenance

When problems occur

Appendix

Cut Preparation

Print and cut separately

Print & Cut

Cut only

Optimize cut quality

2

Examine the pattern and check if the print line ( ① ) and cut line ( ② ) are aligned.

- Print line: ① \*
  - Cut line: ②
- (\*For Confirm Adjust pattern, the pattern is printed in Magenta.)

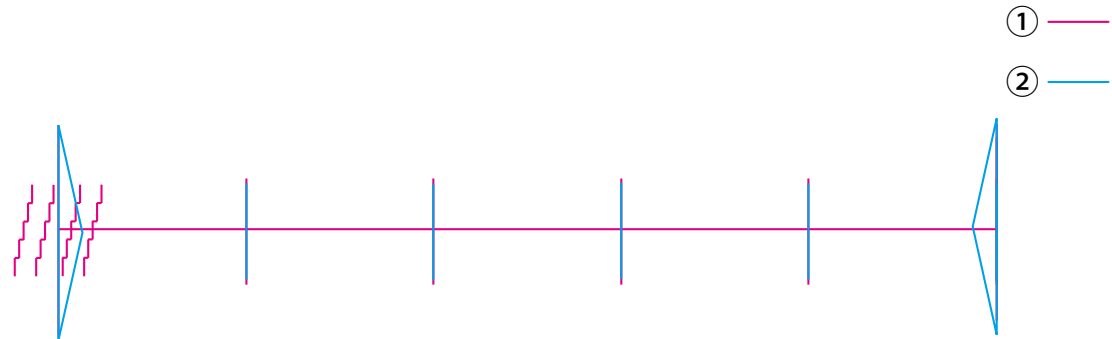

3

If misaligned, go to "1. Initial Adjustment" P.153 to calibrate again.

# Maintenance

About Maintenance	159
Check and replace ink	161
Emptying waste ink tank	168
Cleaning each part	171
Replacing consumable parts	191
Transport and long-term storage	207

Before Use

Basic Operations

Cutting Workflow

Maintenance

When problems occur

Appendix

About Maintenance

Check and replace ink

Emptying waste ink tank

Cleaning each part

Replacing consumable parts

Transport and long-term storage

# About Maintenance

To maintain the performance of this product, please conduct maintenance by yourself. The types of maintenance are shown here.

Before daily operation

 ["Nozzle check and cleaning" P.57](#)

When needed

 ["Replacing with a new ink cartridge" P.163](#)

 ["Emptying waste ink tank" P.168](#)

 ["Head cleaning" P.171](#)

 ["Cleaning the parts around the cap unit" P.182](#)

 ["Cleaning of color sensor" P.184](#)

 ["Cleaning the blade holder" P.186](#)

 ["Cleaning the blade for contour cutter" P.188](#)

 ["Replacing the flushing box pad" P.192](#)

 ["Replacing the blade for sheet cutter" P.195](#)

 ["Replacing the adapter's plug for high-capacity ink pack adapter" P.197](#)

 ["Replacing the cutting mat" P.201](#)

 ["Replacing the blade for contour cutter" P.203](#)

Once a month

 ["Cleaning the parts around the print head" P.177](#)

 ["Cleaning inside the machine" P.189](#)

When not used for more than 1 week

Once a week  ["Head cleaning" P.171](#)

Before Use

Basic Operations

Cutting Workflow

Maintenance

When problems occur

Appendix

About Maintenance

Check and replace ink

Emptying waste ink tank

Cleaning each part

Replacing consumable parts

Transport and long-term storage

 **Important!**

In following cases, please contact your local MUTOH dealer to request service personnel.

- A system error occurred repeatedly.
- A message that notifies life expectancy of various motors, pumps, or print heads were displayed.

 ["Messages and Error Messages" P.220](#)



Before Use

Basic Operations

Cutting Workflow

Maintenance

When problems occur

Appendix

About Maintenance

Check and replace ink

Emptying waste ink tank

Cleaning each part

Replacing consumable parts

Transport and long-term storage

# Check and replace ink

## Check the ink level

- 1 Start MSM and open the remote panel.  
☞ "Displaying remote panel" P.27
- 2 Go to the Printer Status tab > Ink Information and check the ink level.

- As ink is used, the colored scale decreases.

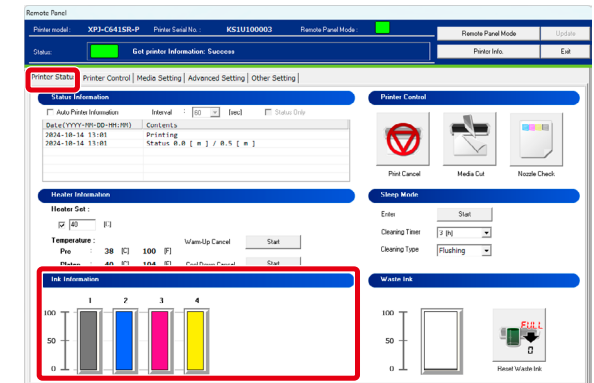

Before Use

Basic Operations

Cutting Workflow

Maintenance

When problems occur

Appendix

About Maintenance

Check and replace ink

Emptying waste ink tank

Cleaning each part

Replacing consumable parts

Transport and long-term storage

## When an ink is nearing replacement

When the ink level becomes low, the error LED on the control panel blinks with beep sound.

### Steps

1 Short press the operation key on the control panel.

- The beep stops.

#### Note

While in sleep mode, the sleep mode continues even after beep stopped.

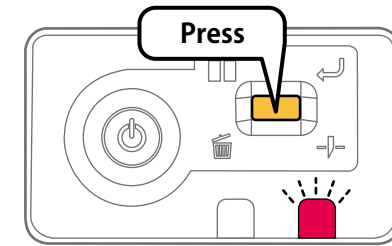

2 Start MSM and open the remote panel.

👉 "Displaying remote panel" P.27

3 Check the ink cartridge that is nearing the replacement.

- Check [Status Information]. For example, if "Ink End : No. 2 4" is displayed, you need to replace the ink cartridges in the slots 2 and 4.

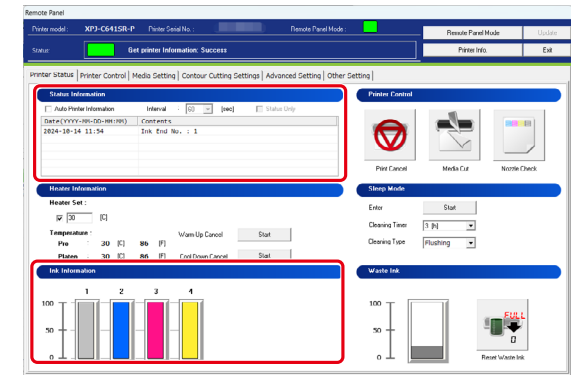

4 Prepare the replacement ink cartridge.

Before Use

Basic Operations

Cutting Workflow

Maintenance

When problems occur

Appendix

About Maintenance

Check and replace ink

Emptying waste ink tank

Cleaning each part

Replacing consumable parts

Transport and long-term storage

## Replacing with a new ink cartridge

When an ink cartridge runs out of ink, the error LED blinks with beep sound and printing pauses. Replacing with the new cartridge will resume printing.



### Warning.



Keep ink cartridge away from fire or heat source to avoid risk of fire.



### Caution



- Be careful not to get ink in your eyes or on skin. Wear protective gloves.
- If in eyes or on skin, immediately flush with water. If left untreated, it could result in bloodshot eyes or mild inflammation. If abnormality persists, seek medical advice immediately.

### Important!

- Do not replace ink cartridge when the printer is powered off. Ink level cannot be detected correctly.
- When moving an ink cartridge from cold place to warm place, rest it in room temperature at least 3 hours before use.

## When using ink cartridges

**1** Short press the operation key on the control panel.

- The beep stops.

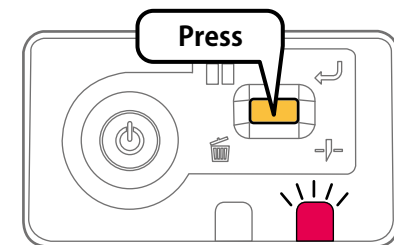

Before Use

Basic Operations

Cutting Workflow

Maintenance

When problems occur

Appendix

About Maintenance

Check and replace ink

Emptying waste ink tank

Cleaning each part

Replacing consumable parts

Transport and long-term storage

**2** Start MSM and open the remote panel.  
👉 "Displaying remote panel" P.27

**3** Confirm which ink cartridge you need to replace.

- Check [Status Information]. In this example, "Ink End : No.1" is displayed, so you will need to replace the ink cartridge in the slot 1.

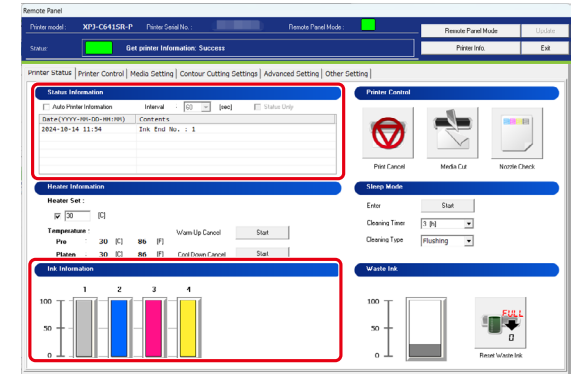

**4** Remove the empty ink cartridge.

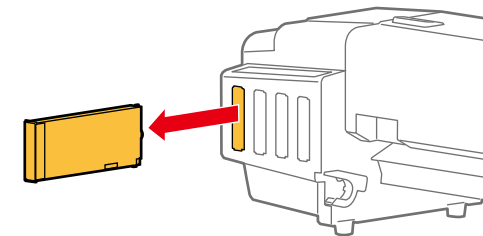

**5** Prepare a new ink cartridge and follow these steps to agitate ink.

1. Hold the ink cartridge with the ink outlet facing up and count for three seconds.
2. Invert it so that the ink outlet faces down and count for three seconds.
3. Repeat this three times.

3 sec.

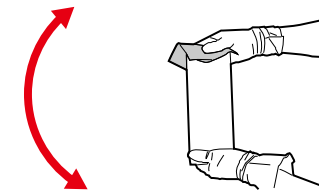

3 sec.



x 3

Before Use

Basic Operations

Cutting Workflow

Maintenance

When problems occur

Appendix

About Maintenance

Check and replace ink

Emptying waste ink tank

Cleaning each part

Replacing consumable parts

Transport and long-term storage

## 6 Insert a new ink cartridge.

- Match the color of the ink cartridge with the color of the label attached to the ink slot.
- Face the arrow mark upward.
- Insert it all the way in.

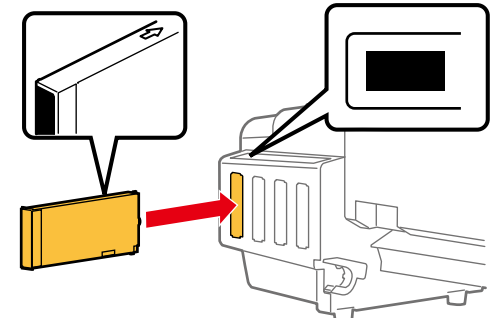

### Note

While in sleep mode, the sleep mode continues even after beep stopped.

## When using ink bags with high-capacity ink pack adapters

### 1 Short press the operation key on the control panel.

- The beep stops.

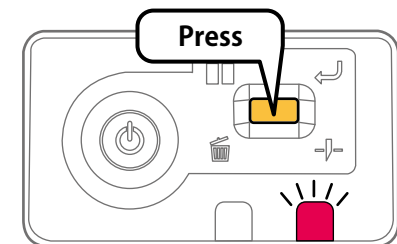

### 2 Start MSM and open the remote panel.

-  ["Displaying remote panel" P.27](#)

Before Use

Basic Operations

Cutting Workflow

Maintenance

When problems occur

Appendix

About Maintenance

Check and replace ink

Emptying waste ink tank

Cleaning each part

Replacing consumable parts

Transport and long-term storage

**3** In [Ink Information], check the ink bag you will replace.

- Also check [Status Information]. In this example, "Ink End : No. 1" is displayed, so you will need to replace the ink bag in the slot 1.



**4** Remove the high-capacity ink pack adapter of the ink bag you will replace.

**Important !!**

Do not remove the ink bag without removing the high-capacity ink pack adapter from the machine. The ink level information will be rewritten and those smartchip card and ink bag will no longer be available.

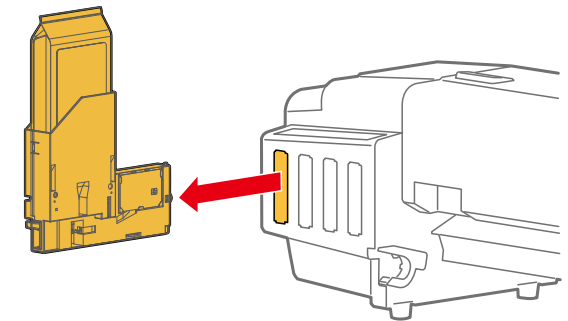

**5** Take a new ink bag out of its packaging.

**Important !!**

Open the packaging of the ink bag immediately prior to installing to the high-capacity ink pack adapter. Leaving it open for a long time could prevent normal printing.

Before Use

Basic Operations

Cutting Workflow

Maintenance

When problems occur

Appendix

About Maintenance

Check and replace ink

Emptying waste ink tank

Cleaning each part

Replacing consumable parts

Transport and long-term storage

**6** Insert the ink bag and a smartchip card to the high-capacity ink pack adapter.

 **Note**

For insertion and removal procedure, see the operation manual supplied with the high-capacity ink pack adapter.

**7** Follow these steps to agitate ink.

1. Hold the ink bag with the high-capacity ink pack adapter from the top and bottom so that the ink bag is not removed. Face the ink outlet up and count for three seconds.
2. Invert it so that the ink outlet faces down and count for three seconds.
3. Repeat this three times.

3 sec.



3 sec.

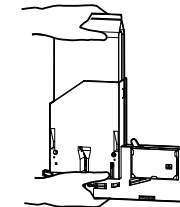

x 3

**8** Insert the high-capacity ink pack adapter into the slot.

- Match the color of the high-capacity ink pack adapter with the color of the label attached to the ink slot.
- Insert it all the way in.

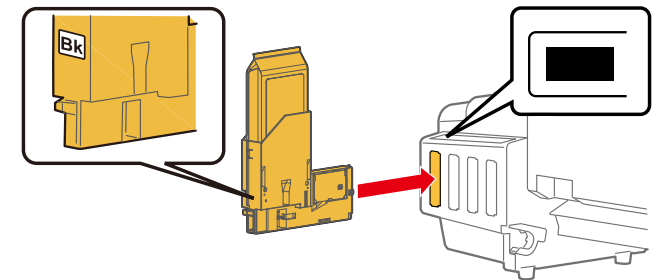

 **Note**

While in sleep mode, the sleep mode continues even after beep stopped.

Before Use

Basic Operations

Cutting Workflow

Maintenance

When problems occur

Appendix

About Maintenance

Check and replace ink

Emptying waste ink tank

Cleaning each part

Replacing consumable parts

Transport and long-term storage

# Emptying waste ink tank

When the certain amount of ink is used on the machine, the error LED on the control panel turns on with beep sound. Drain the waste ink into a container like PET bottle to empty the tank.



## Caution



- Be careful not to get ink in your eyes or on skin. Wear protective gloves.
- If in eyes or on skin, immediately flush with water. If left untreated, it could result in bloodshot eyes or mild inflammation. If abnormality persists, seek medical advice immediately.

## Important!

When moving this product, empty the waste ink tank even if it is short distance.  
If ink splashes inside the waste ink tank while being moved, it will cause damage to the product.

## Steps

- 1 Check that the error LED is ON.

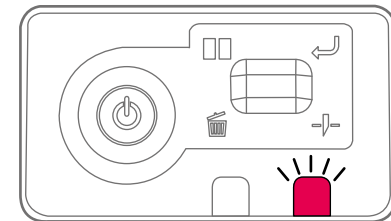

- 2 Start MSM and open the remote panel.

 ["Displaying remote panel" P.27](#)



Before Use

Basic Operations

Cutting Workflow

Maintenance

When problems occur

Appendix

About Maintenance

Check and replace ink

Emptying waste ink tank

Cleaning each part

Replacing consumable parts

Transport and long-term storage

3 Check [Status Information] in the Printer Status tab.

- The waste ink tank full message is displayed.

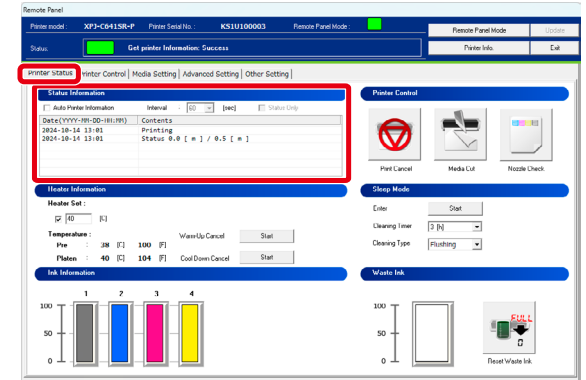

4 Prepare a container like PET bottle to drain waste ink.

**Important!**

The capacity of waste ink tank is 1,400 ml. Make sure to prepare a container that has enough capacity.

5 Pull out the tip of the drain tube.

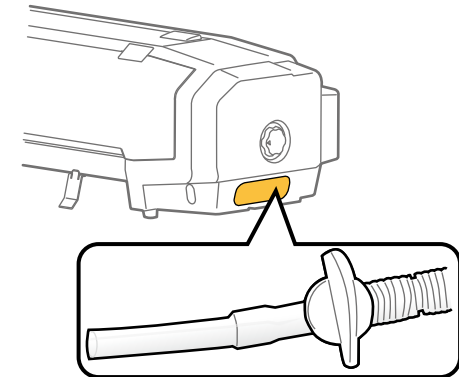

Before Use

Basic Operations

Cutting Workflow

Maintenance

When problems occur

Appendix

About Maintenance

Check and replace ink

Emptying waste ink tank

Cleaning each part

Replacing consumable parts

Transport and long-term storage

1. Insert the tip of drain tube into the container.
2. Turn the valve as shown in the illustration.
3. Drain waste ink into the container.
4. Once you finish emptying the tank, turn the valve back in place.

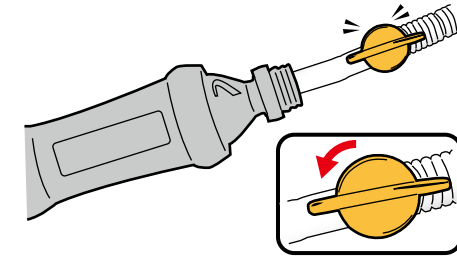

### Warning.



Waste fluids collected from the machine are classified as an industrial waste product. You are obligated to properly dispose of waste fluid in compliance with Wastes Disposal and Public Cleansing Act and local ordinances.  
Delegate disposal to an industrial waste disposal contractor.

- 7 Click [Reset Waste Ink].
  - A confirmation message appears.

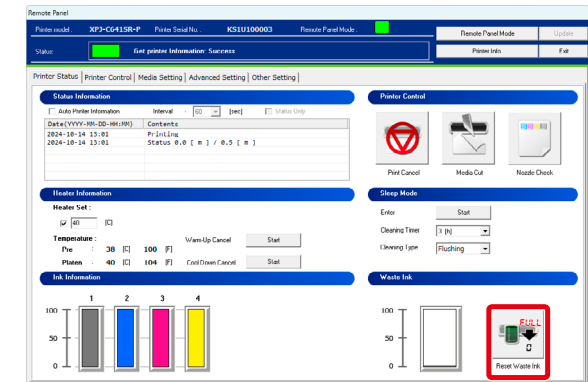

- 8 Click [Yes].
  - The waste ink counter will reset.

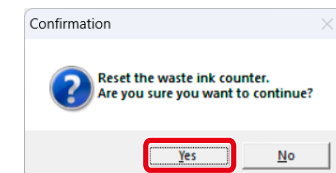

Before Use

Basic Operations

Cutting Workflow

Maintenance

When problems occur

Appendix

About Maintenance

Check and replace ink

Emptying waste ink tank

Cleaning each part

Replacing consumable parts

Transport and long-term storage

# Cleaning each part

## Head cleaning

If there are missing lines in the nozzle check print, perform a head cleaning. It consumes some ink.

The following cleaning modes are available in this product. Select an appropriate mode depending on the result of nozzle check print.

Short cleaning	Consumes less ink than "Normal" cleaning.
Normal cleaning	Select this mode if there are several missing lines in the nozzle check print.
Long cleaning	Consumes more ink than "Normal" cleaning. Perform "Long" cleaning if nozzle clogging persists even after "Normal" cleaning was performed.
Little Charge	Gives higher cleaning, but consumes large amount of ink.
[Initial Charge]	Gives higher cleaning than [Little Charge], but consumes quite large amount of ink.

### Important!

When performing a "Little Charge", please comply with the following. If cleaning is interrupted, it may consume more ink.

- Do not turn off the machine.
- Do not disconnect the power cord.
- Do not open the front cover.
- Do not remove ink cartridges.
- Do not use an ink cartridge with less ink.

Before Use

Basic Operations

Cutting Workflow

Maintenance

When problems occur

Appendix

About Maintenance

Check and replace ink

Emptying waste ink tank

Cleaning each part

Replacing consumable parts

Transport and long-term storage

## Head Cleaning steps

1 Start MSM and open the remote panel.  
☞ "Displaying remote panel" P.27

2 Click the Printer Control tab.

- The Printer Control tab page opens.

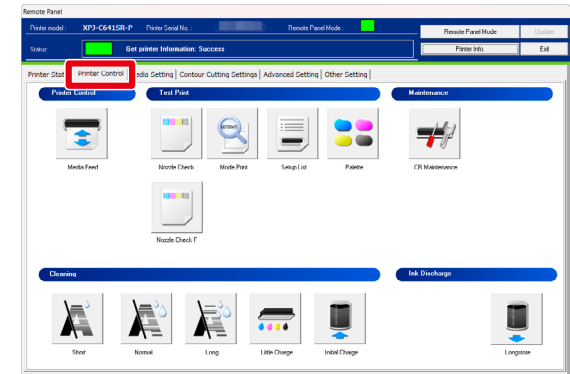

3 Click to select the cleaning mode (Short/ Normal/ Long) from the Cleaning menu.

- The cleaning cycle begins.

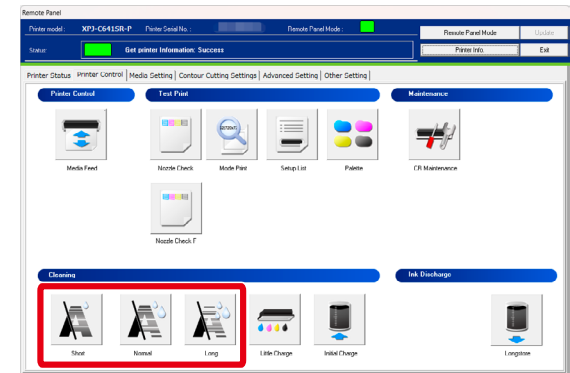

Before Use

Basic Operations

Cutting Workflow

**Maintenance**

When problems occur

Appendix

About Maintenance

Check and replace ink

Emptying waste ink tank

**Cleaning each part**

Replacing consumable parts

Transport and long-term storage

#### 4 Run a nozzle check print.

- If the problem persists, repeat cleaning and nozzle check.

👉 ["Head Cleaning steps" P.172](#)

#### Note

If missing lines persists after several attempts of "Normal" cleaning, try following the below steps:

1. Perform the "Long" cleaning (If the problem persists, go to the next step).
2. Perform the following cleaning (If the problem persists, go to the next step).
  - 👉 ["Cleaning the parts around the print head" P.177](#)
  - 👉 ["Cleaning the cleaning wiper" P.180](#)
3. Go to Maintenance menu > Cleaning menu and perform "Little Charge" cleaning (If the problem persists, go to the next step).
  - 👉 ["Head cleaning" P.171](#)
4. If nozzle still clogs, you can select the nozzles that do not suffer from clogging to continue printing from the Nozzle Area Select menu in the Advance Setting tab in MSM.

Before Use

Basic Operations

Cutting Workflow

Maintenance

When problems occur

Appendix

About Maintenance

Check and replace ink

Emptying waste ink tank

Cleaning each part

Replacing consumable parts

Transport and long-term storage

## Cleaning each part of the machine

To keep the product in good condition all the time, please clean each part of the machine regularly or when required. When cleaning the parts marked with asterisk mark (\*), you will need to put the machine in the CR maintenance mode.







 ["Put the machine in the CR maintenance mode" P.175](#)



### Caution



- Be careful not to get ink in your eyes or on skin. Wear protective gloves.
- If in eyes or on skin, immediately flush with water. If left untreated, it could result in bloodshot eyes or mild inflammation. If abnormality persists, seek medical advice immediately.

Parts need to be cleaned	When to clean
Parts around the print head*	<ul style="list-style-type: none"><li>• lines are blurred or image is partially not printed even after head cleaning was performed</li><li>• ink smudge appears.</li></ul>  <a href="#">"Cleaning the parts around the print head" P.177</a>
Cleaning wiper*	Lines are blurred or image is partially not printed even after head cleaning was performed  <a href="#">"Cleaning the cleaning wiper" P.180</a>
Parts around the cap unit*	Once a week.  <a href="#">"Cleaning the parts around the cap unit" P.182</a>
Color sensor*	<ul style="list-style-type: none"><li>• Repeatedly failed to perform automatic print quality calibration</li><li>• Repeatedly failed to read crop mark</li></ul>  <a href="#">"Cleaning of color sensor" P.184</a>
Blade holder	Dust or small pieces of media are accumulated in the blade holder.  <a href="#">"Cleaning the blade holder" P.186</a>
Blade for contour cutter	Dirt like oil appears on the cut line.  <a href="#">"Cleaning the blade for contour cutter" P.188</a>
Inside the machine	<ul style="list-style-type: none"><li>• Once a month</li><li>• You see ink dirt or dust on the machine.</li></ul>  <a href="#">"Cleaning inside the machine" P.189</a>

Before Use

Basic Operations

Cutting Workflow

Maintenance

When problems occur

Appendix

About Maintenance

Check and replace ink

Emptying waste ink tank

Cleaning each part

Replacing consumable parts

Transport and long-term storage

## Put the machine in the CR maintenance mode

1 Start MSM and open the remote panel.  
☞ "Launching/ Opening/Exiting MSM" P.26

2 Click the Printer Control tab.

- The Printer Control tab page opens.

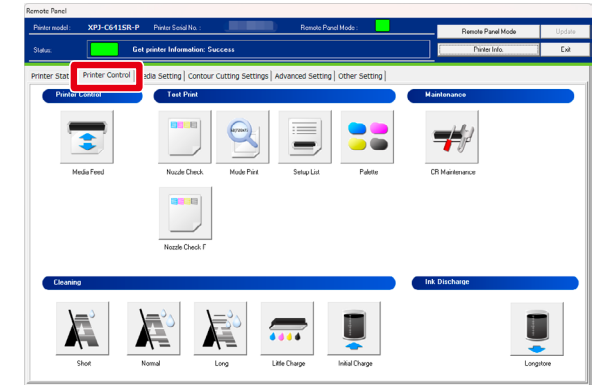

3 Click [CR Maintenance] in the Maintenance menu.

- The CR Maintenance page appears.

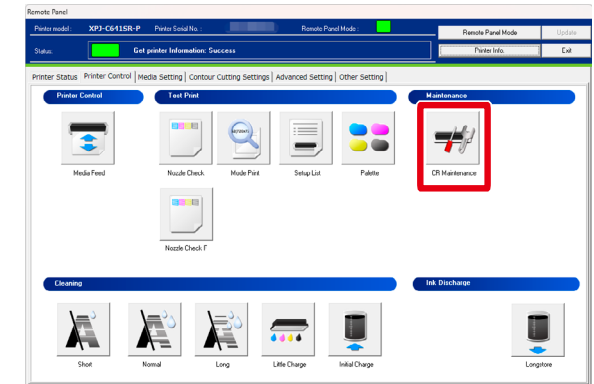

Before Use

Basic Operations

Cutting Workflow

Maintenance

When problems occur

Appendix

About Maintenance

Check and replace ink

Emptying waste ink tank

Cleaning each part

Replacing consumable parts

Transport and long-term storage

4 Click [Start].

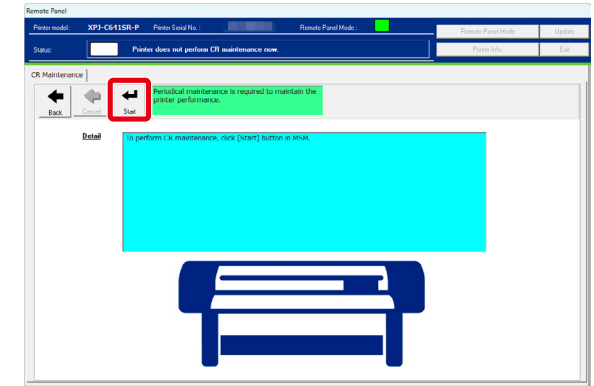

5 Short press the operation key on the control panel.  
• The carriage moves to the maintenance position.

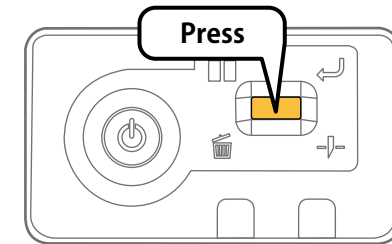



Before Use

Basic Operations

Cutting Workflow

Maintenance

When problems occur

Appendix

About Maintenance

Check and replace ink

Emptying waste ink tank

Cleaning each part

Replacing consumable parts

Transport and long-term storage

## Cleaning the parts around the print head

When to clean :

- Once a week
- lines are blurred or image is partially not printed even after head cleaning was performed

Item required :

- Cleaning stick

### Important !!

Make sure to follow the instructions below during cleaning:

- Use a dry cleaning stick. Using a wet cleaning stick could cause damage to the print head.
- Do not touch the tip of the cleaning stick. If finger print oil gets on the stick, it will damage the print head.
- Do not reuse cleaning sticks. This will cause dust to adhere, leading to malfunction.
- The standard maintenance time is within 5 minutes. If it takes longer, the print head will get dried, causing the damage.

## Cleaning steps

- 1 Put the machine in the CR maintenance mode.  
☞ "Put the machine in the CR maintenance mode" P.175
- 2 Open the front cover.
- 3 Check the bottom side of the carriage to see if dust or ink is accumulated on the following parts:
  - ① : Parts around the print head
  - ② : Head guide

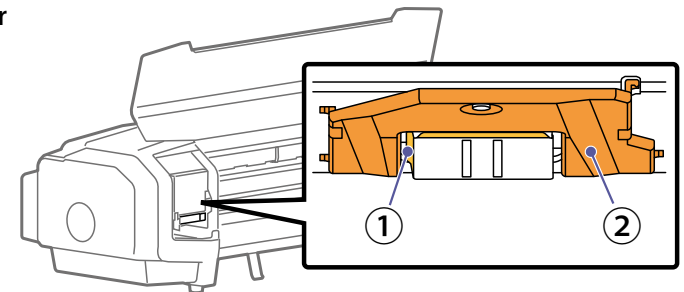

Before Use

Basic Operations

Cutting Workflow

Maintenance

When problems occur

Appendix

About Maintenance

Check and replace ink

Emptying waste ink tank

Cleaning each part

Replacing consumable parts

Transport and long-term storage

**4** If dust or ink is accumulated, use a cleaning stick to clean the following parts:

- ③ : Left side of the parts around the print head
- ④ : Left side of the head guide

**Important !!**

- Do not touch the surface of print head (⑤) with finger or cleaning stick. This will cause damage to the print head.
- Do not touch the platen or media guide. It may be hot.

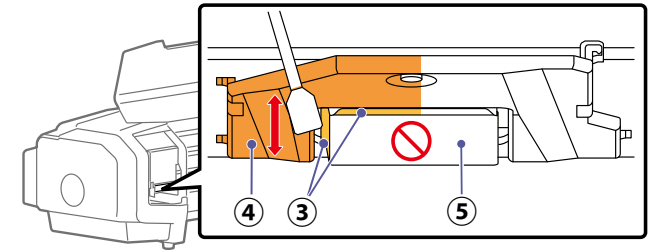

**5** Close the front cover once.

**6** Next clean the right side of the parts around the print head. Short press the operation key on the control panel.

- Inside the front cover, the carriage will move to the maintenance position on the origin side.

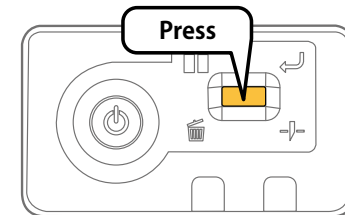

**7** Open the front cover.

Before Use

Basic Operations

Cutting Workflow

Maintenance

When problems occur

Appendix

About Maintenance

Check and replace ink

Emptying waste ink tank

Cleaning each part

Replacing consumable parts

Transport and long-term storage

**8** Use the cleaning stick to clean the following parts:

- ① : Right side of the parts around the print head
- ② : Right side of the head guide

**Important !!**

- Do not touch the surface of print head (③) with finger or cleaning stick. This will cause damage to the print head.
- Do not touch the platen or media guide. It may be hot.

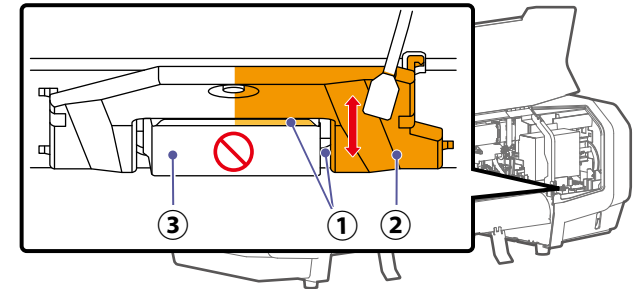

**9** Close the front cover.

**10** Short press the operation key on the control panel.

- Inside the front cover, the carriage will move back in place.

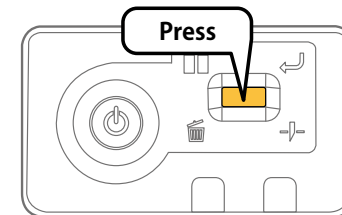

Before Use

Basic Operations

Cutting Workflow

Maintenance

When problems occur

Appendix

About Maintenance

Check and replace ink

Emptying waste ink tank

Cleaning each part

Replacing consumable parts

Transport and long-term storage

## Cleaning the cleaning wiper

When to clean :

- Once a week
- lines are blurred or image is partially not printed even after head cleaning was performed

What you need:

- Cleaning stick

### Important!

Make sure to follow the instructions below:

- Do not touch the cleaning wiper and head cap unit with your hand. If finger print oil gets on these parts, it will prevent normal cleaning.
- Use a dry cleaning stick. Using a wet cleaning stick could cause damage to the print head.
- Do not reuse cleaning sticks. This will cause dust to adhere, leading to malfunction.
- The standard maintenance time is within 5 minutes. If it takes longer, the print head will get dried, causing the damage.

## Cleaning steps

- 1 Put the machine in the CR maintenance mode.  
👉 ["Put the machine in the CR maintenance mode" P.175](#)
- 2 Open the front cover.
- 3 Use the cleaning stick to wipe off the cleaning wiper.
  - Wipe off the left side of the wiper back and forth.

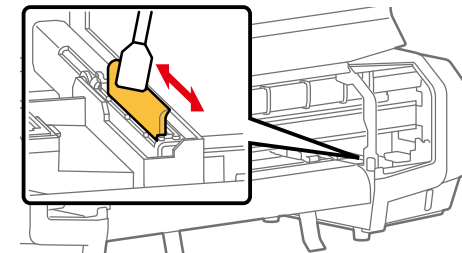

Before Use

Basic Operations

Cutting Workflow

Maintenance

When problems occur

Appendix

About Maintenance

Check and replace ink

Emptying waste ink tank

Cleaning each part

Replacing consumable parts

Transport and long-term storage

**4** Wipe off the right side of the wiper back and forth.

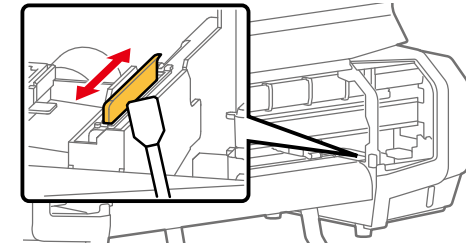

**5** Wipe off the base of the right side of the wiper back and forth.

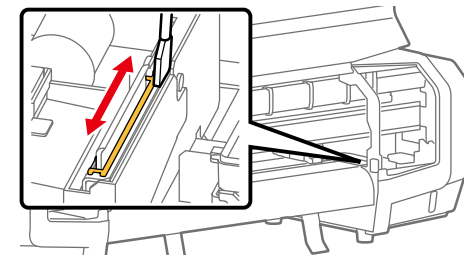

**6** Close the front cover.

**7** Short press the operation key on the control panel.

- Inside the front cover, the carriage will move to the maintenance position on the origin side.

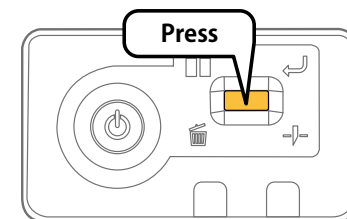

**8** Once the carriage has moved to the maintenance position on the origin side, short press the operation key again.

- Inside the front cover, the carriage will move back in place.

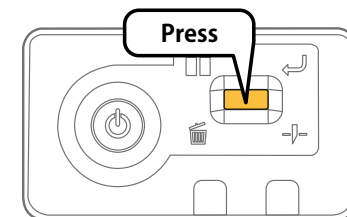

Before Use

Basic Operations

Cutting Workflow

Maintenance

When problems occur

Appendix

About Maintenance

Check and replace ink

Emptying waste ink tank

Cleaning each part

Replacing consumable parts

Transport and long-term storage

## Cleaning the parts around the cap unit

When to clean :

- Once a week

What you need:

- Cleaning stick

### Important !!

Make sure to follow the instructions below during cleaning:

- Use a dry cleaning stick. Using a wet cleaning stick could cause damage to the print head.
- Do not touch the tip of the cleaning stick. If finger print oil gets on the stick, it will damage the print head.
- Do not reuse cleaning sticks. This will cause dust to adhere, leading to malfunction.
- The standard maintenance time is within 5 minutes. If it takes longer, the print head will get dried, causing the damage.

**1** Put the machine in the CR maintenance mode.  
☞ "Put the machine in the CR maintenance mode" P.175

**2** Open the front cover.

**3** Using a cleaning stick, clean the outer edge ( ① ) and inner edge ( ② ) of the cap unit to wipe off the sticking ink and dust.

- ① : outer edge of cap unit
- ② : inner edge of cap unit
- ③ : absorber (Do not touch)

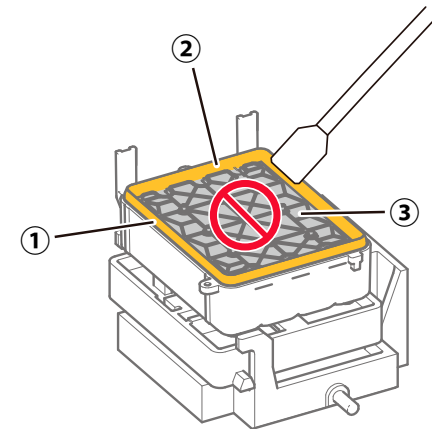

Before Use

Basic Operations

Cutting Workflow

Maintenance

When problems occur

Appendix

About Maintenance

Check and replace ink

Emptying waste ink tank

Cleaning each part

Replacing consumable parts

Transport and long-term storage

**4** Close the front cover.

**5** Short press the operation key on the control panel.

- Inside the front cover, the carriage will move to the maintenance position on the origin side.

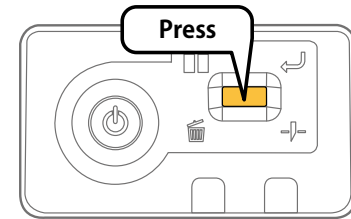

**6** Once the carriage has moved to the maintenance position on the origin side, short press the operation key again.

- Inside the front cover, the carriage will move back in place.

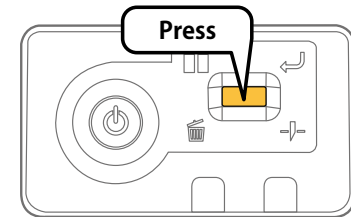

**Note**

Put the used cleaning stick in a plastic bag and dispose of it according to the local regulations.

Before Use

Basic Operations

Cutting Workflow

Maintenance

When problems occur

Appendix

About Maintenance

Check and replace ink

Emptying waste ink tank

Cleaning each part

Replacing consumable parts

Transport and long-term storage

## Cleaning of color sensor

When to clean:

- Repeatedly failed to perform automatic print quality calibration
- Repeatedly failed to read crop marks

What you need:

- cleaning stick
- ethanol (more than 50% ethanol)

### Important !!

Follow the instruction below during cleaning:

- Do not push hard on the color sensor glass with cleaning stick. This will cause damage to the glass.
- Do not reuse the cleaning stick. This will cause dust to adhere to the sensor, leading to malfunction.
- The standard maintenance time is about five minutes. If it takes longer, the print head will get dried, causing the damage.

**1** Put the machine in the CR maintenance mode.  
☞ "Put the machine in the CR maintenance mode" P.175

**2** Open the front cover.

**3** Using the cleaning stick dampened with small amount of ethanol, gently clean the bottom of the carriage to wipe off ink or dust.

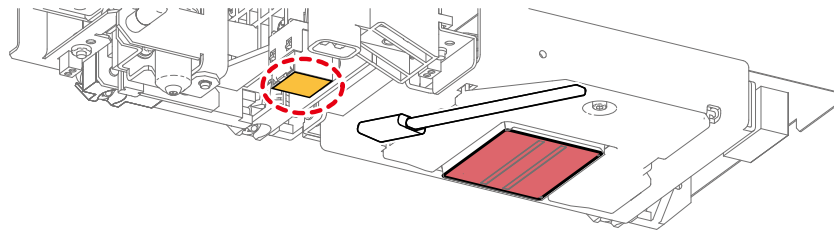

**Yellow square:** Clean this part (Do not push hard on the glass)

**Red square:** Never touch the print head surface.



Before Use

Basic Operations

Cutting Workflow

Maintenance

When problems occur

Appendix

About Maintenance

Check and replace ink

Emptying waste ink tank

Cleaning each part

Replacing consumable parts

Transport and long-term storage

4 Close the front cover.

5 Short press the operation key on the control panel.

- Inside the front cover, the carriage will move to the maintenance position on the origin side.

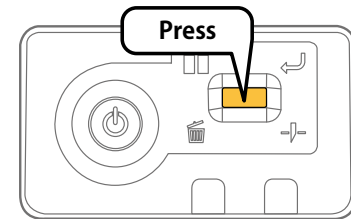

6 Once the carriage has moved to the maintenance position on the origin side, short press the operation key again.

- Inside the front cover, the carriage will move back in place.

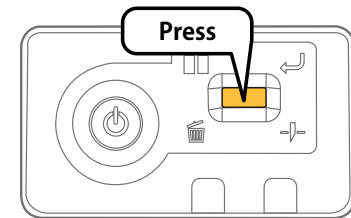

 **Important !!**

If the problem persists, please contact your local MUTOH dealer.

 **Note**

Put the used cleaning stick in a plastic bag and dispose of it according to the local regulations.

Before Use

Basic Operations

Cutting Workflow

Maintenance

When problems occur

Appendix

About Maintenance

Check and replace ink

Emptying waste ink tank

Cleaning each part

Replacing consumable parts

Transport and long-term storage

## Cleaning the blade holder

When to clean:

- Dust or small pieces of media are accumulated in the blade holder.

**1** Refer to the following section to remove the blade holder.  
👉 "Install the blade holder into the machine" P.115

**2** Refer to the Removal steps of the following section and remove the cutter blade.  
👉 "Removing a blade" P.112

**3** Remove the top of the blade holder.

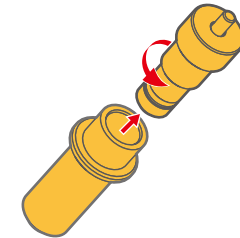

**4** Use an air duster or similar tool to remove dust and small pieces of media built inside the blade holder.

**5** Attach the top of the blade holder.

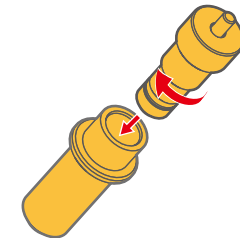

Before Use

Basic Operations

Cutting Workflow

Maintenance

When problems occur

Appendix

About Maintenance

Check and replace ink

Emptying waste ink tank

Cleaning each part

Replacing consumable parts

Transport and long-term storage

- 
- 6** Refer to the installation steps of the following section and attach the blade to the blade holder.  
👉 ["Installing a blade" P.111](#)

**Important !!**

After cleaning the blade holder, adjust the blade depth.

👉 ["Adjust blade depth" P.113](#)

- 
- 7** Attach the blade holder to the machine.  
👉 ["Install the blade holder into the machine" P.115](#)
-

Before Use

Basic Operations

Cutting Workflow

Maintenance

When problems occur

Appendix

About Maintenance

Check and replace ink

Emptying waste ink tank

Cleaning each part

Replacing consumable parts

Transport and long-term storage

## Cleaning the blade for contour cutter

When to clean:

- Dirt like oil appears on the cut line.

What you need:

- Paper towel or soft cloth

1

Follow the section "Install the blade holder into the machine" to remove the blade holder.

 ["Install the blade holder into the machine" P.115](#)

2

Follow the the section "Removing a blade" of "Install a blade on the blade holder" to remove the blade from the holder.

 ["Removing a blade" P.112](#)

3

Using the paper towel or soft cloth, clean the blade to remove dirt.

4

Install the blade on the blade holder.

 ["Install a blade on the blade holder" P.111](#)

### Important !!

Once cleaning is done, adjust the blade depth.

 ["Adjust blade depth" P.113](#)

5

Install the blade holder into the machine.

 ["Install the blade holder into the machine" P.115](#)

Before Use

Basic Operations

Cutting Workflow

**Maintenance**

When problems occur

Appendix

About Maintenance

Check and replace ink

Emptying waste ink tank

**Cleaning each part**

Replacing consumable parts

Transport and long-term storage

## Cleaning inside the machine

When to clean:

- Once a month
- you see ink or dust on the machine

What you need:

- Soft brush
- Paper towel or soft cloth
- Ethanol (more than 50% ethanol)
- Polyethylene gloves (commercially available)



### Caution



- Before performing this cleaning, make sure to turn off the machine and unplug it.
- Be careful not to get ink in your eyes or on skin. Wear protective gloves. If in eyes or on skin, immediately flush with water. If left untreated, it could result in bloodshot eyes or mild inflammation. If abnormality persists, seek medical advice immediately.

**1** Remove a roll media.

**2** Check that the machine is powered off.

**3** Open the front cover.

### Important !!

The heater temperature becomes high right after printing.  
Touch the platen or media guide and allow it to cool down if it is hot.

Before Use

Basic Operations

Cutting Workflow

Maintenance

When problems occur

Appendix

About Maintenance

Check and replace ink

Emptying waste ink tank

Cleaning each part

Replacing consumable parts

Transport and long-term storage

- 4 Use a soft brush to clean the dust off the pinch roller arms.

**Important !!**

Do not use air duster to clean the dust inside the printer. This will cause dust to accumulate on the moving parts, leading to damage or noise.

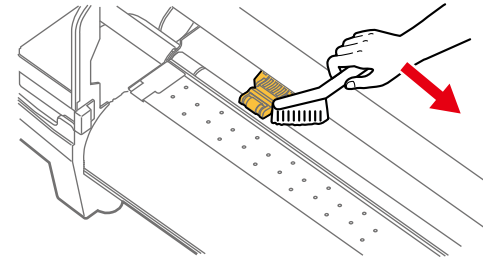

- 5 Using a paper towel or a soft cloth dampened with small amount of ethanol, clean the dust on the platen, media guide and edge holders.

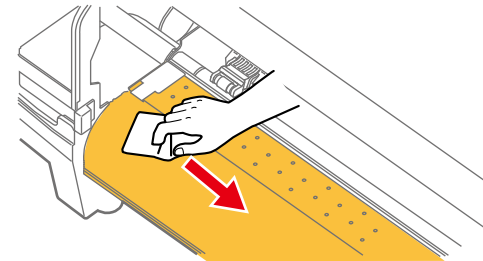

- 6 Use a soft brush to clean the dirt on the grit roller (silver part).

**Important !!**

Manually turn the grit roller on the left side of the front cover to change the surface to clean.

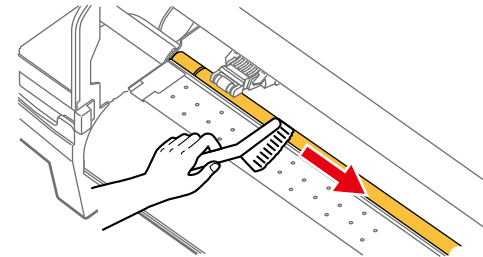

- 7 Close the front cover.

Before Use

Basic Operations

Cutting Workflow

Maintenance

When problems occur

Appendix

About Maintenance

Check and replace ink

Emptying waste ink tank

Cleaning each part

Replacing consumable parts

Transport and long-term storage

# Replacing consumable parts







In order to maintain consistent printing quality, the following parts must be replaced periodically.



## Caution



- Be careful not to get ink in your eyes or on skin. Wear protective gloves.
- If in eyes or on skin, immediately flush with water. If left untreated, it could result in bloodshot eyes or mild inflammation. If abnormality persists, seek medical advice immediately.

Parts	When to replace
Flushing box pad	When looking from the side, the ink deposits on the flushing pad is visible through the flushing box frame. (Approximately every two months) * *It depends on your use frequency. Check it periodically.  <a href="#">"Replacing the flushing box pad" P.192</a>
Sheet Cutter	<ul style="list-style-type: none"><li>• When the cutter cannot cut media cleanly.</li><li>• When the cut is fuzzy.</li></ul>  <a href="#">"Replacing the blade for sheet cutter" P.195</a>
Plug of high-capacity ink pack adapter	It depends on your use frequency. Check it periodically.  <a href="#">"Replacing the adapter's plug for high-capacity ink pack adapter" P.197</a>
Cutting mat	<ul style="list-style-type: none"><li>• When you notice many visible cutting marks</li><li>• When cutting is inconsistent</li></ul>  <a href="#">"Replacing the cutting mat" P.201</a>
Contour Cutter	When cutting is inconsistent  <a href="#">"Replacing the blade for contour cutter" P.203</a>
Blade Holder	<ul style="list-style-type: none"><li>• The tip of the blade holder is worn out and the cutting is inconsistent.</li><li>• Even after cleaning the blade holder, cutting becomes unstable due to small pieces of media buildup</li></ul>  <a href="#">"Replacing the blade holder" P.204</a>
Cleaning wiper	Once every twelve months  <a href="#">"Replacing the cleaning wiper" P.205</a>

Before Use

Basic Operations

Cutting Workflow

Maintenance

When problems occur

Appendix

About Maintenance

Check and replace ink

Emptying waste ink tank

Cleaning each part

Replacing consumable parts

Transport and long-term storage

## Replacing the flushing box pad

The flushing box is a part that collects inks spitted from the print head. Please replace the flushing box pad periodically. If used without replacing, it can cause damage to the print head.

When to replace:

- When looking from the side, the ink deposits on the flushing pad is visible through the flushing box frame. (Approximately every two months) \*
- \*It depends on your use frequency. Check it periodically.

What you need:

- Flushing box pad
- Waste paper (paper that ink does not bleed through)
- Polyethylene gloves (commercially available)

### Checking steps

1 Open the front cover.

2 Check the pad of the flushing box.

- (When looking from the side) if the ink deposits on the flushing pad is visible through the flushing box frame, you need to replace it.



3 Close the front cover.

### Replacing steps

1 Put the machine in the CR maintenance mode.

👉 "Put the machine in the CR maintenance mode" P.175



Before Use

Basic Operations

Cutting Workflow

Maintenance

When problems occur

Appendix

About Maintenance

Check and replace ink

Emptying waste ink tank

Cleaning each part

Replacing consumable parts

Transport and long-term storage

2 Open the front cover.

3 Remove the pad from the flushing box.  
• Lift the tab of the pad to unhook it.

**Important !!**

When removing the pad from the flushing box, be careful of ink dripping.

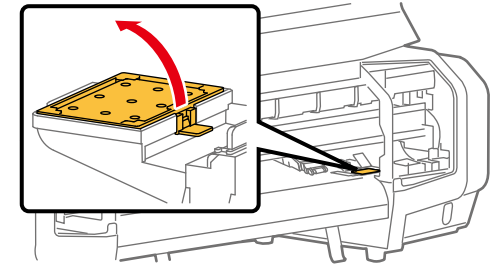

4 Attach a new pad to the flushing box.

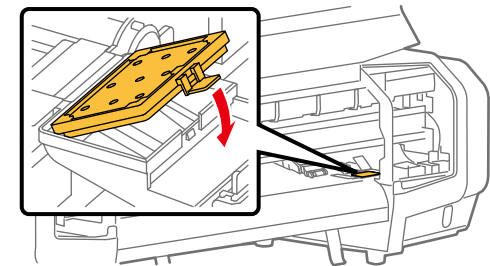

5 Close the front cover.

6 Short press the operation key on the control panel.

• Inside the front cover, the carriage will move to the maintenance position on the origin side.

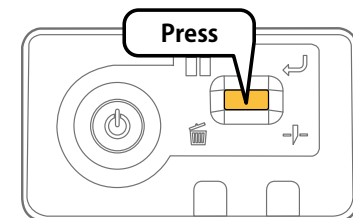

Before Use

Basic Operations

Cutting Workflow

**Maintenance**

When problems occur

Appendix

About Maintenance

Check and replace ink

Emptying waste ink tank

Cleaning each part

**Replacing consumable parts**

Transport and long-term storage

7

Once the carriage has moved to the maintenance position on the origin side, short press the operation key again.

- Inside the front cover, the carriage will move back in place.

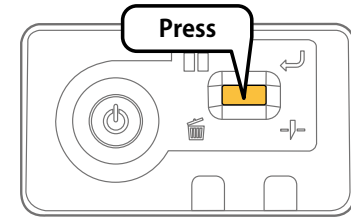

Before Use

Basic Operations

Cutting Workflow

Maintenance

When problems occur

Appendix

About Maintenance

Check and replace ink

Emptying waste ink tank

Cleaning each part

Replacing consumable parts

Transport and long-term storage

## Replacing the blade for sheet cutter

When to replace:

- When the cutter cannot cut a roll media cleanly.
- When the cut is fuzzy

What you need:

- Replacement cutter blade



### Caution



- Do not push the tab on the cutter holder too hard or release suddenly. There is a spring under the cutter so that the cutter may jump out from the holder.
- Do not touch the cutter blade. It may cause injury.

1 Open the front cover.

2 Lightly push down the tab on the cutter holder ( ① ), and turn the cutter cap in the direction shown in the illustration ( ② ).

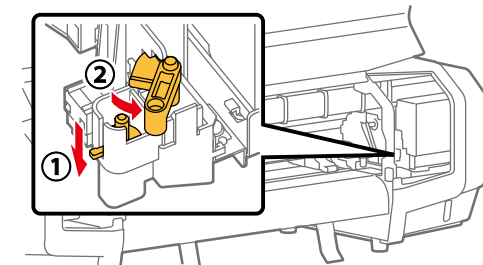

3 Remove the cutter.

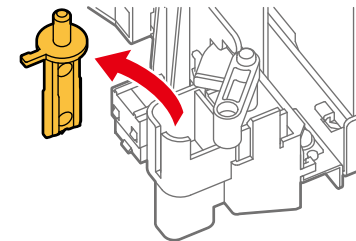

Before Use

Basic Operations

Cutting Workflow

**Maintenance**

When problems occur

Appendix

About Maintenance

Check and replace ink

Emptying waste ink tank

Cleaning each part

**Replacing consumable parts**

Transport and long-term storage

**4**

**Attach a new cutter.**

- Put the cutter cap back to the original position.

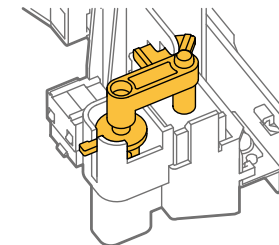

**5**

**Close the front cover.**

Before Use

Basic Operations

Cutting Workflow

Maintenance

When problems occur

Appendix

About Maintenance

Check and replace ink

Emptying waste ink tank

Cleaning each part

Replacing consumable parts

Transport and long-term storage

## Replacing the adapter's plug for high-capacity ink pack adapter

You will need to replace the plug of the high-capacity ink pack adapter after the adapter has been removed and loaded for the certain number of times.

### Note

For proper instructions of high-capacity ink pack adapter, see the high-capacity ink pack adapter's operation manual.

## 1. Checking the life of adapter's plug

The plug life decreases as the high-capacity ink pack adapter is removed and inserted. Follow these steps to check the life of the plug periodically.

**1** Start MSM and open the remote panel.  
☞ "Displaying remote panel" P.27

**2** Click the [Plug Lifetime] tab.

- The plug life is indicated the number of green stars. For a new plug, five stars appear.
- The number of stars decreases one by one (one star = 20%) as the plug is nearing the end of life.
- The yellow star indicates that the plug has reached nearing the end of life. Please prepare the replacement plug.
- When the red star appears, you have to replace with a new plug.

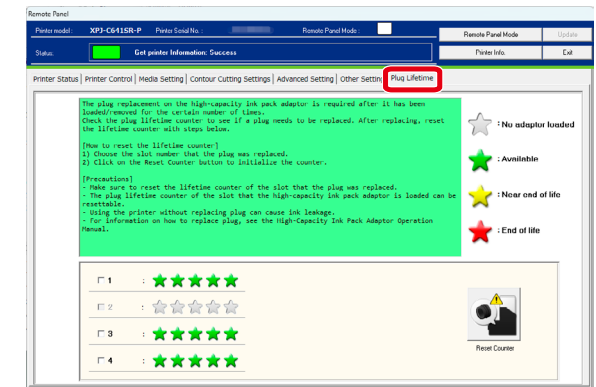

### Note

Replacement plugs are supplied with high-capacity ink pack adapter.

Before Use

Basic Operations

Cutting Workflow

Maintenance

When problems occur

Appendix

About Maintenance

Check and replace ink

Emptying waste ink tank

Cleaning each part

Replacing consumable parts

Transport and long-term storage

## 2. Replacing with a new plug

When the plug has reached the end of life, the error LED on the control panel turns on and the message appears in the Status Information on MSM.

Follow these steps to replace with a new plug.

Once you replace it and reset the life counter for plug, the error LED will turn off.

1 Start MSM and open the remote panel.  
👉 "Displaying remote panel" P.27

2 Check the Status Information.

- For example, when the message "Replace plug. No.2 4" is displayed, the plug of the high-capacity ink pack adapter inserted in the slots 2 and 4 must be replaced.

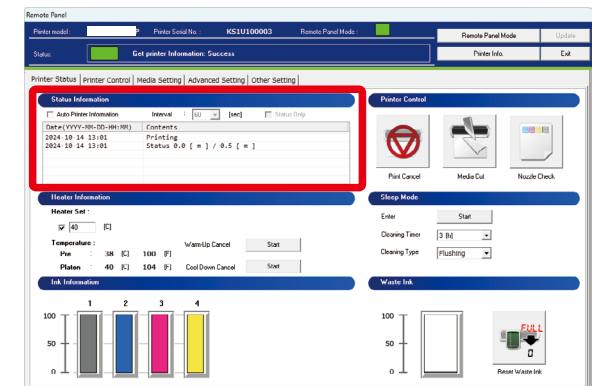

3 Refer to the High-capacity ink pack adapter operation manual to replace with a new plug.  
👉 High-Capacity Pack Adapter Instruction Manual "3.3 Adapter Plug Replacement"

4 Reset the plug lifetime counter of the ink slot you have replaced the plug.  
👉 "3. Resetting the plug lifetime counter" P.199

Before Use

Basic Operations

Cutting Workflow

Maintenance

When problems occur

Appendix

About Maintenance

Check and replace ink

Emptying waste ink tank

Cleaning each part

Replacing consumable parts

Transport and long-term storage

### 3. Resetting the plug lifetime counter

After the plug of high-capacity ink pack adaptor has replaced, follow these steps to reset the plug lifetime counter.

- 1 Start MSM and open the remote panel.  
👉 "Displaying MSM" P.26
- 2 In the Plug Lifetime tab, check the ink slot number you have replaced the plug.

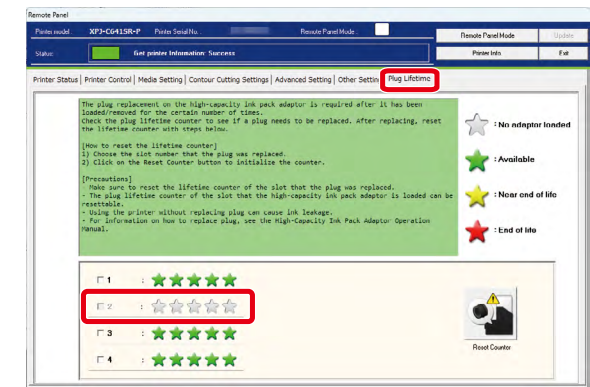

- 3 Click [Reset Counter].

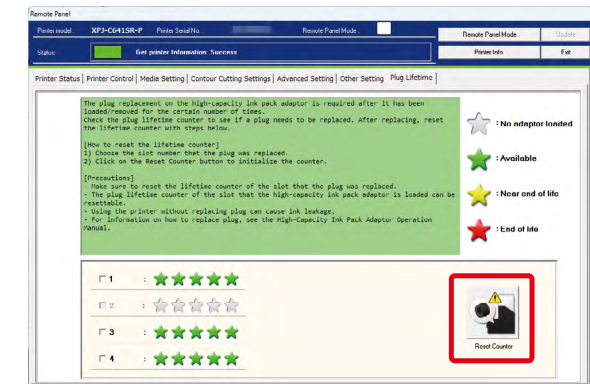

Before Use

Basic Operations

Cutting Workflow

Maintenance

When problems occur

Appendix

About Maintenance

Check and replace ink

Emptying waste ink tank

Cleaning each part

Replacing consumable parts

Transport and long-term storage

4 Click [Yes].

- The counter of the selected ink slot will reset.

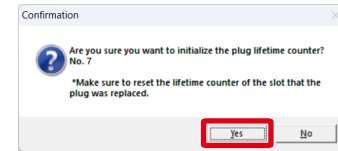

**Important!**

Never reset the lifetime counter of the plug you have not replaced. This will cause ink leakage.



Before Use

Basic Operations

Cutting Workflow

Maintenance

When problems occur

Appendix

About Maintenance

Check and replace ink

Emptying waste ink tank

Cleaning each part

Replacing consumable parts

Transport and long-term storage

## Replacing the cutting mat

When to replace:

- When you notice many visible cutting marks
- When cutting is inconsistent

What you need:

- Replacement cutting mat
- Ethanol (more than 50% ethanol)

**1** Open the front cover.

**2** Slide the edge holders to the left side of the printer and remove them from the platen.

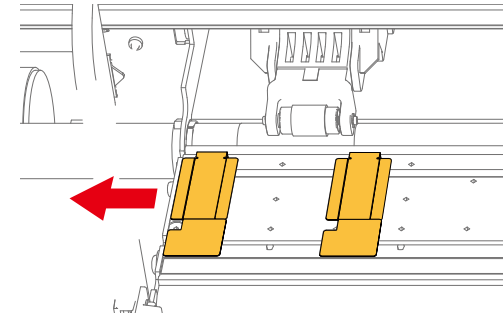

**3** Slowly peel off the cutting mat to remove it from the platen.

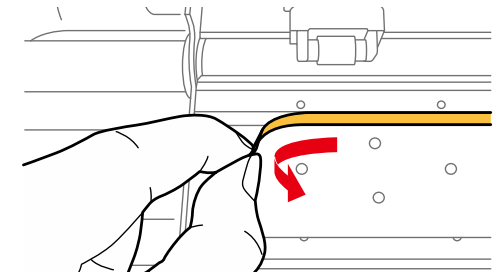

Before Use

Basic Operations

Cutting Workflow

Maintenance

When problems occur

Appendix

About Maintenance

Check and replace ink

Emptying waste ink tank

Cleaning each part

Replacing consumable parts

Transport and long-term storage

4 Remove the adhesive material left on the platen.

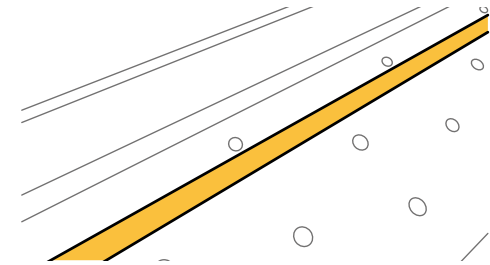

5 Use a soft cloth dampened with small amount of ethanol to wipe off the adhesive.

6 Once ethanol is completely dried, attach the new cutting mat along the groove.

- Push the mat to remove air bubble.

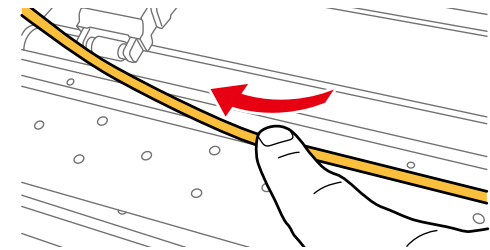

7 Attach the edge holders from the left side of the platen.

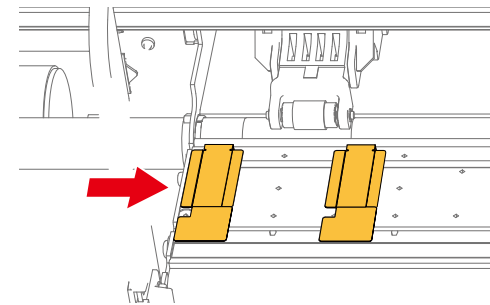

8 Close the front cover.

Before Use

Basic Operations

Cutting Workflow

Maintenance

When problems occur

Appendix

About Maintenance

Check and replace ink

Emptying waste ink tank

Cleaning each part

Replacing consumable parts

Transport and long-term storage

## Replacing the blade for contour cutter

When to replace:

- When cutting is inconsistent

What you need:

- Replacement blade for contour cutter

1

Refer to the following procedure and remove the blade holder.

 ["Install the blade holder into the machine" P.115](#)

2

Refer to the Removal steps of the following section and remove the cutter blade.

 ["Removing a blade" P.112](#)

3

Refer to the installation steps of the following section to attach the new blade.

 ["Installing a blade" P.111](#)

4

Refer to the following section to adjust the blade depth.

 ["Adjust blade depth" P.113](#)

5

Refer to the following section to attach the blade holder.

 ["Install the blade holder into the machine" P.115](#)

Before Use

Basic Operations

Cutting Workflow

Maintenance

When problems occur

Appendix

About Maintenance

Check and replace ink

Emptying waste ink tank

Cleaning each part

Replacing consumable parts

Transport and long-term storage

## Replacing the blade holder

When to replace:

- The tip of the blade holder is worn out and the cutting is inconsistent.
- Even after cleaning the blade holder, cutting becomes unstable due to small pieces of media buildup

What you need:

- Replacement blade holder

**1** Refer to the following section to remove the blade holder.  
👉 ["Install the blade holder into the machine" P.115](#)

**2** Refer to the installation steps of the following section and attach the blade to the new blade holder.  
👉 ["Installing a blade" P.111](#)

**3** Refer to the following section to adjust the blade depth.  
👉 ["Adjust blade depth" P.113](#)

**4** Refer to the following section and attach the blade holder.  
👉 ["Install the blade holder into the machine" P.115](#)

Before Use

Basic Operations

Cutting Workflow

Maintenance

When problems occur

Appendix

About Maintenance

Check and replace ink

Emptying waste ink tank

Cleaning each part

Replacing consumable parts

Transport and long-term storage

## Replacing the cleaning wiper

When to replace:

- Approximately every 12 months

What you need:

- Replacement cleaning wiper
- Waste paper (paper that ink does not bleed through)
- Polyethylene gloves

### Replacement procedure

- 1 Put the machine into the CR maintenance mode.  
 "Put the machine in the CR maintenance mode" P.175

- 2 Open the front cover.

- 3 Cover the platen with the waste paper.

#### Important !!

Ink may drip from the cleaning wiper. We recommend covering the floor with paper as well.

- 4 Remove the cleaning wiper.
  - Lift the hook and remove the cleaning wiper.

#### Note

Put the used wiper in a plastic bag and dispose of it according to the local regulations.

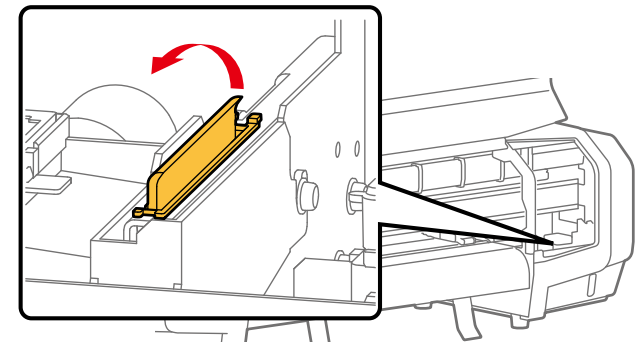

Before Use

Basic Operations

Cutting Workflow

Maintenance

When problems occur

Appendix

About Maintenance

Check and replace ink

Emptying waste ink tank

Cleaning each part

Replacing consumable parts

Transport and long-term storage

**5** Follow these steps to attach a new cleaning wiper.

- a) Slide the front side of the new cleaning wiper into its slot.
- b) Press the wiper hook down until it clicks into place.

**Important !!**

Do not touch the rubber part of the cleaning wiper with bare hands. If sebum gets on it, it will damage the print head.

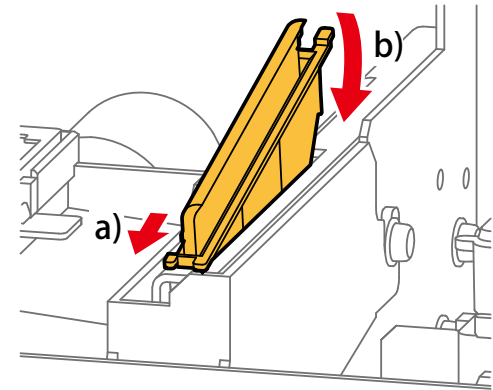

**6** Close the front cover.

**7** Short press the operation key on the control panel.

- Inside the front cover, the carriage will move to the maintenance position on the origin side.

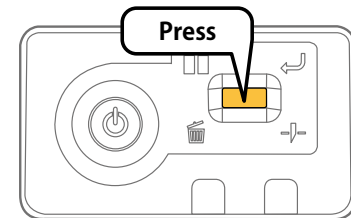

**8** Once the carriage has moved to the maintenance position on the origin side, short press the operation key again.

- Inside the front cover, the carriage will move back in place.

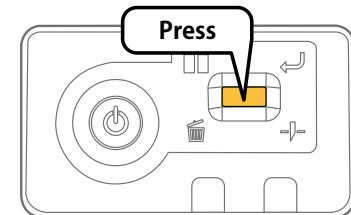

Before Use

Basic Operations

Cutting Workflow

Maintenance

When problems occur

Appendix

About Maintenance

Check and replace ink

Emptying waste ink tank

Cleaning each part

Replacing consumable parts

Transport and long-term storage

# Transport and long-term storage

Refer to this section when you transport the product or you are not using it for a long period of time.

## Transporting the machine

When transporting the product, you will need to perform "Longstore" to flush ink out of the machine, empty the waste ink tank and secure the print head with the shipping bracket. Failure to do so could cause ink leakage, leading to damage to the print head. When you use the machine again, you will do the machine installation and initial ink charging.

### Important!

- When moving this machine, empty the waste ink tank even moving short distance. Failure to do so may result in damage to the machine.
- Do not tilt, lean or turn the machine upside down. The ink inside the machine may spill. MUTOH does not guarantee that the machine can run properly.

## 1. Flushing ink out of the printer and emptying the waste ink tank

- 1 Start MSM and open the remote panel.  
👉 ["Displaying remote panel" P.27](#)

- 2 Click the Printer Control tab.

- The Printer Control tab page opens.

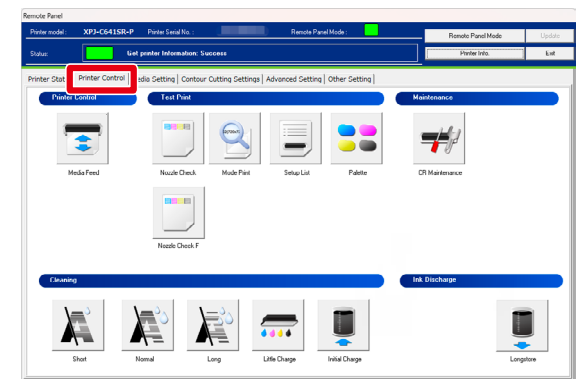

Before Use

Basic Operations

Cutting Workflow

Maintenance

When problems occur

Appendix

About Maintenance

Check and replace ink

Emptying waste ink tank

Cleaning each part

Replacing consumable parts

Transport and long-term storage

### 3 Click [Longstore] in the Ink Discharge menu.

- The machine will begin flushing ink out.

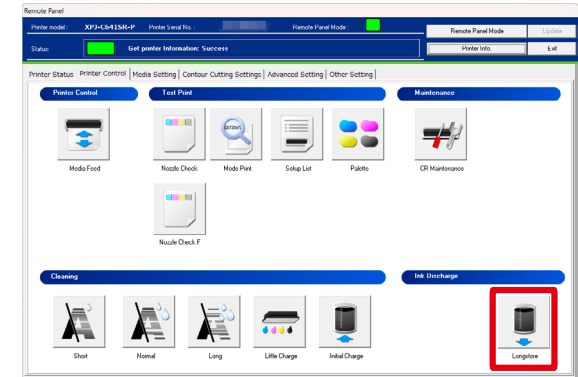

### 4 Click [Start] in the Longstore tab page.

- Follow the on-screen instruction to do the flushing.
- Once finished, do not restart the machine or perform initial ink charging.

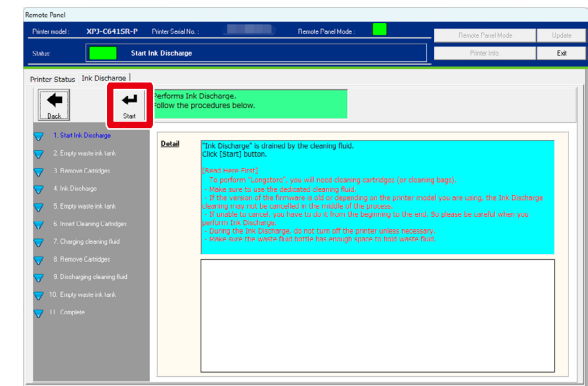

### 5 Empty the waste ink tank. 👉 "Emptying waste ink tank" P.168

### 6 Press the Power button to turn off the machine.

- The blue lamp turns off.
- The machine begins powering off.

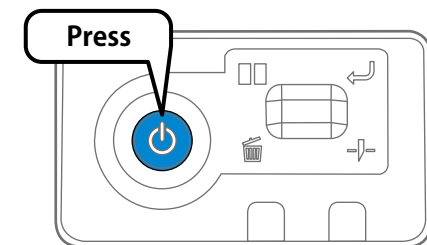



Before Use

Basic Operations

Cutting Workflow

Maintenance

When problems occur

Appendix

About Maintenance

Check and replace ink

Emptying waste ink tank

Cleaning each part

Replacing consumable parts

Transport and long-term storage

## 2. Repacking

1 Remove all the cables including power cord.

2 Open the front cover.

3 Attach the carriage shipping bracket with screw.

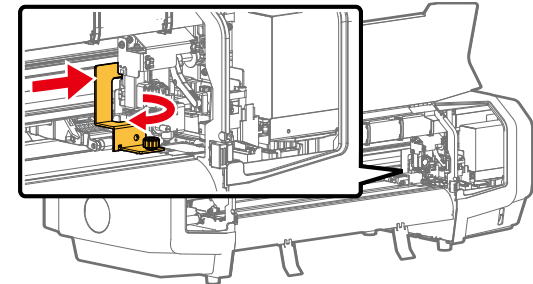

4 Secure the contour cutter with tape.

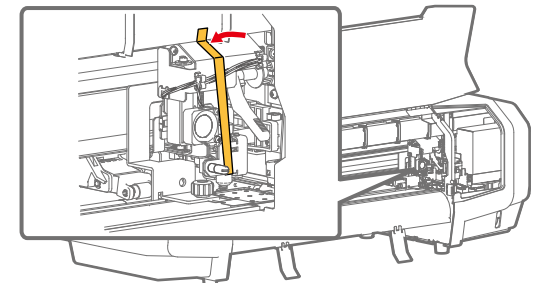

5 Secure the sheet cutter with tape.

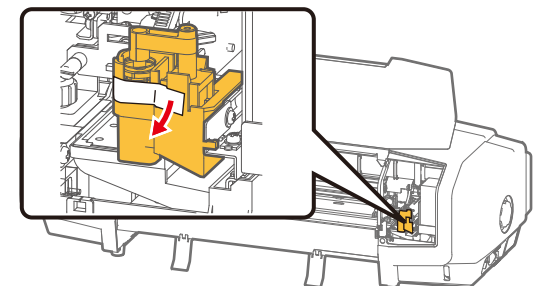

Before Use

Basic Operations

Cutting Workflow

Maintenance

When problems occur

Appendix

About Maintenance

Check and replace ink

Emptying waste ink tank

Cleaning each part

Replacing consumable parts

Transport and long-term storage

- 6 Move the edge holders to the center of the platen and secure with tape.

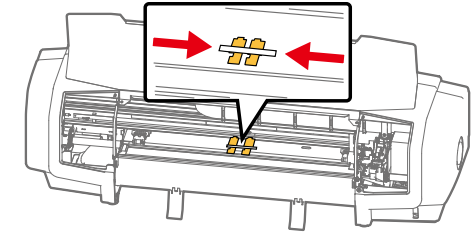

- 7 Attach the steel veyor protector and secure with tape.

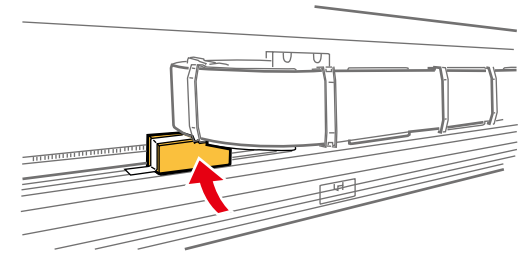

- 8 Turn the media fixing handle to unlock it.

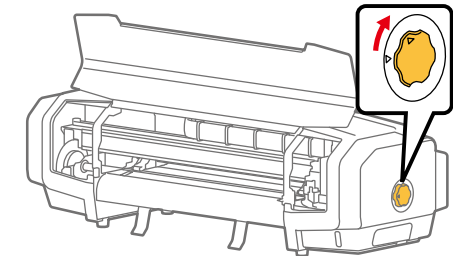

- 9 Attach the roller protection sheet.

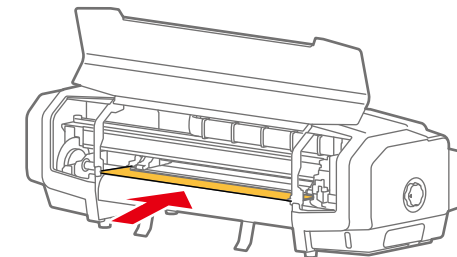

- 10 Close the front cover.

Before Use

Basic Operations

Cutting Workflow

Maintenance

When problems occur

Appendix

About Maintenance

Check and replace ink

Emptying waste ink tank

Cleaning each part

Replacing consumable parts

Transport and long-term storage

**11** Remove the two media guides.

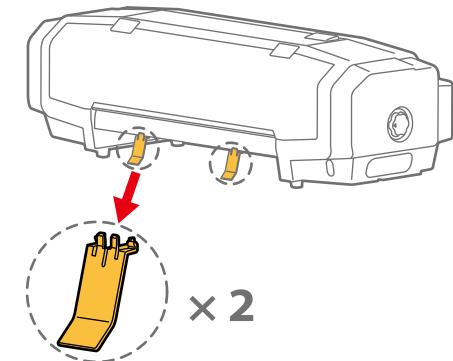

**12** Remove the cable tie and cord clamp.

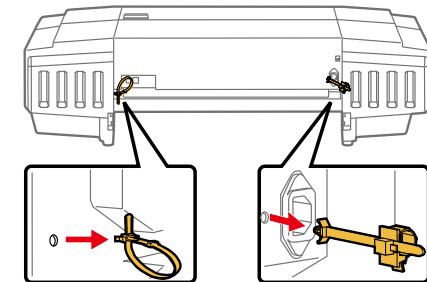

**13** Attach the cushioning materials and put the product in the packaging box.

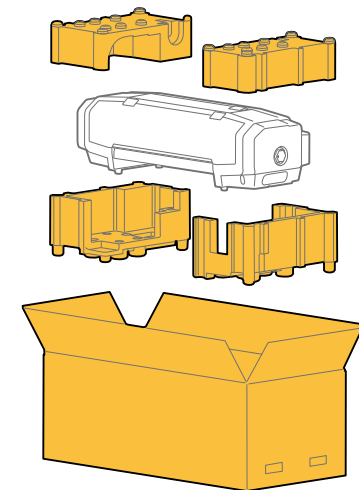

Before Use

Basic Operations

Cutting Workflow

Maintenance

When problems occur

Appendix

About Maintenance

Check and replace ink

Emptying waste ink tank

Cleaning each part

Replacing consumable parts

Transport and long-term storage

 Note

When moving this product, hold the following parts of the product.

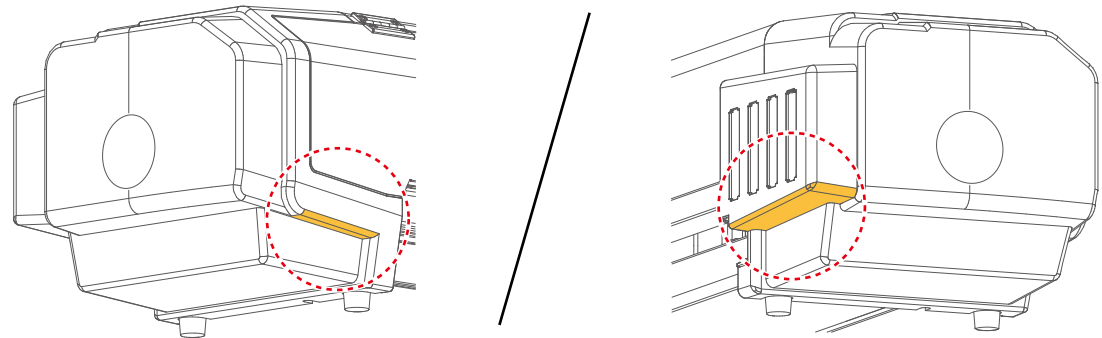

### 3. Reinstalling the product

- 1** Follow the instructions on the Startup Guide and unpack and assemble the product.
  - Do the procedures until the section "Preparations".
- 2** Perform initial ink charging.
  - 👉 [Performing initial ink charging P.213](#)

Before Use

Basic Operations

Cutting Workflow

Maintenance

When problems occur

Appendix

About Maintenance

Check and replace ink

Emptying waste ink tank

Cleaning each part

Replacing consumable parts

Transport and long-term storage

## Performing initial ink charging

- 1 Press the power button on this machine.
  - The blue lamp on the panel will light up.
  - Machine initialization begins.

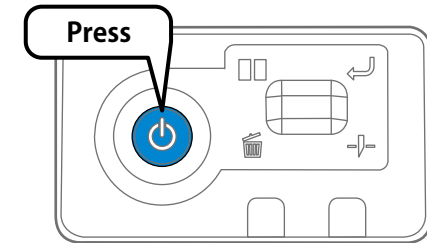

- 2 Start MSM and open the remote panel.  
👉 "Displaying remote panel" P.27

- 3 Click the Printer Control tab.
  - The Printer Control tab page opens.

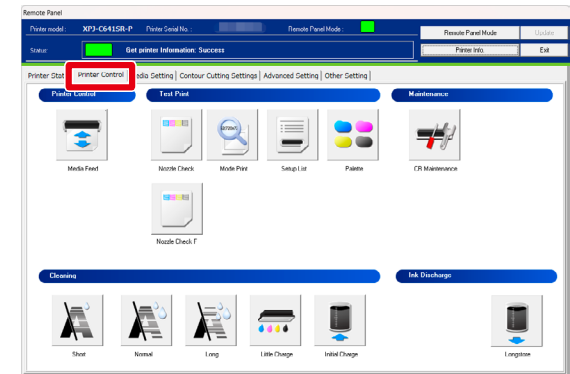

Before Use

Basic Operations

Cutting Workflow

Maintenance

When problems occur

Appendix

About Maintenance

Check and replace ink

Emptying waste ink tank

Cleaning each part

Replacing consumable parts

Transport and long-term storage

4 Click [Initial Charge] in the Maintenance menu.

- The Initial Charge page appears.

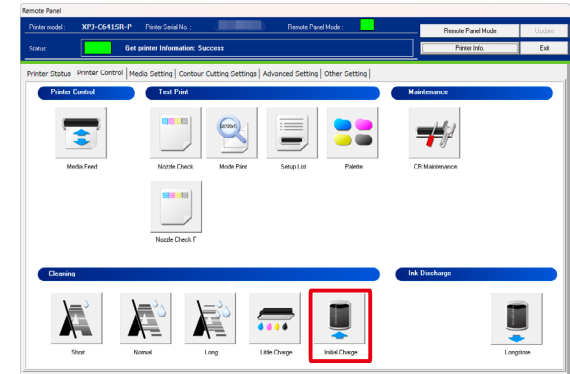

5 Empty the waste ink tank and click [Start].

👉 "Emptying waste ink tank" P.168

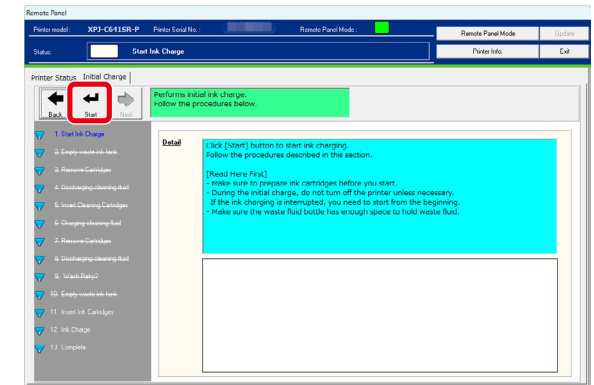

6 • If ink cartridges are installed in the ink slots, remove all of them.

- The machine begins initial ink charging.

👉 "When using ink cartridges" P.215

👉 "When using ink bags with high-capacity ink pack adapters" P.216

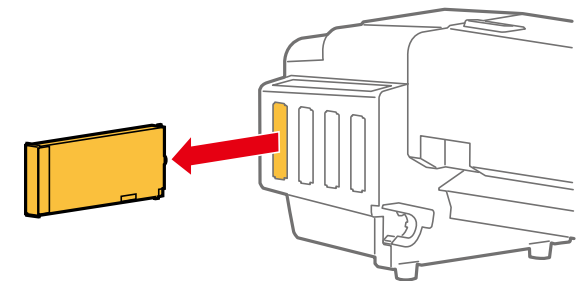

Before Use

Basic Operations

Cutting Workflow

Maintenance

When problems occur

Appendix

About Maintenance

Check and replace ink

Emptying waste ink tank

Cleaning each part

Replacing consumable parts

Transport and long-term storage

## When using ink cartridges

**1** Prepare new ink cartridges and follow these steps to agitate ink.

1. Hold the ink cartridge with the ink outlet facing up and count for three seconds.
2. Invert it so that the ink outlet faces down and count for three seconds.
3. Repeat this three times.

### Important!

Make sure to use new ink cartridges. If a used ink cartridge does not have enough ink, it will run out of ink during initial ink charging and will consume more ink.

3 sec.

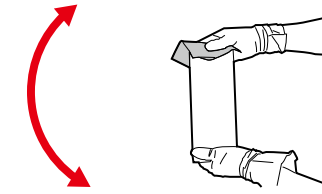

3 sec.



x 3

**2** Insert the ink cartridges.

- Match the color of the ink cartridge with the color of the label attached to the ink slot.
- Face the arrow mark upward.
- Insert it all the way in.

### Note

Once all the ink cartridges are inserted, the machine begins filling ink.

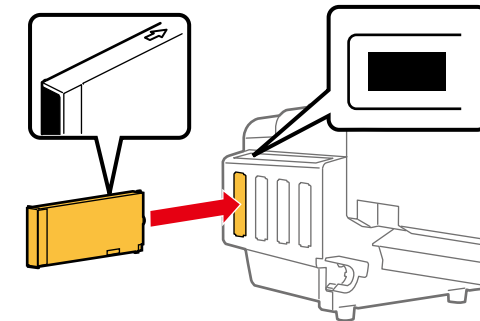

Before Use

Basic Operations

Cutting Workflow

Maintenance

When problems occur

Appendix

About Maintenance

Check and replace ink

Emptying waste ink tank

Cleaning each part

Replacing consumable parts

Transport and long-term storage

3 In the [Complete] step, click [Back].

- This will end the ink charging process.

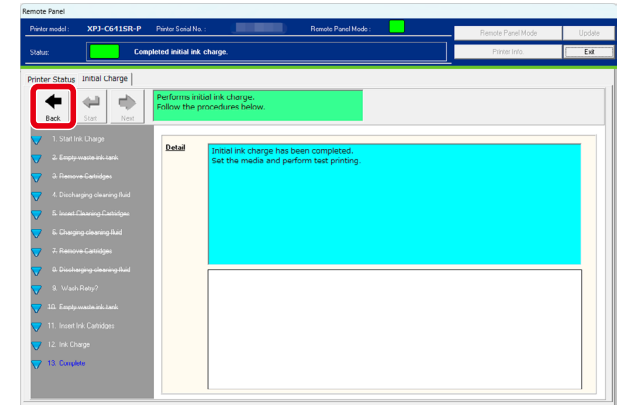

## When using ink bags with high-capacity ink pack adapters

1 Take a new ink bag out of its packaging.

### Important !!

- Make sure to use new ink bags. If a used ink bag does not have enough ink, it will run out of ink during initial ink charging and will consume more ink.
- Open the packaging of the ink bag immediately prior to installing to the high-capacity ink pack adapter. Leaving it open for a long time could prevent normal printing.

2 Insert the ink bag and a smartchip card to the high-capacity ink pack adapter.

### Note

For insertion and removal procedure, see the operation manual supplied with the high-capacity ink pack adapter.



Before Use

Basic Operations

Cutting Workflow

Maintenance

When problems occur

Appendix

About Maintenance

Check and replace ink

Emptying waste ink tank

Cleaning each part

Replacing consumable parts

Transport and long-term storage

### 3 Follow these steps to agitate ink.

1. Hold the ink bag with the high-capacity ink pack adapter from the top and bottom so that the ink bag is not removed. Face the ink outlet up and count for three seconds.
2. Invert it so that the ink outlet faces down and count for three seconds.
3. Repeat this three times.

3 sec.

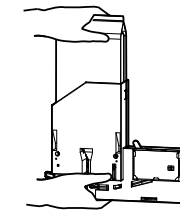

3 sec.



x 3

### 4 Insert the high-capacity ink pack adapters into each slot.

- Match the color of the high-capacity ink pack adapter with the color of the label attached to the ink slot.
- Insert it all the way in.

#### Important !!

Do not insert the high-capacity ink pack adapter into the slot without the ink bag installed. The ink level information will be rewritten and those smartchip card and ink bag will no longer be available.

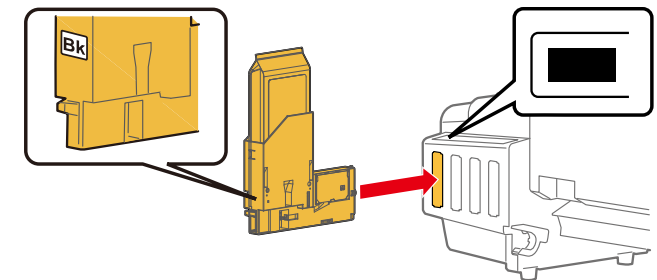

### 5 In the [Complete] step, click [Back].

- This will end the ink charging process.

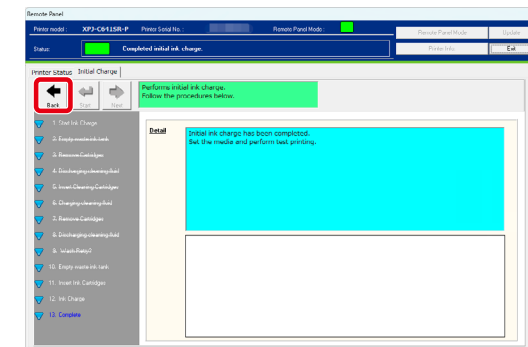

Before Use

Basic Operations

Cutting Workflow

Maintenance

When problems occur

Appendix

About Maintenance

Check and replace ink

Emptying waste ink tank

Cleaning each part

Replacing consumable parts

Transport and long-term storage

## When not using the machine for a long time

- 1 • If you are not using the product for a long period of time, flush ink out of the machine and empty the waste ink tank.  
👉 ["Transporting the machine" P.207](#) > ["1. Flushing ink out of the printer and emptying the waste ink tank" P.207](#)
  - Unlock the media fixing handle and raise the pinch rollers.
- 2 When using the product again, perform initial ink charging.  
👉 ["Performing initial ink charging" P.213](#)

# When problems occur

Messages and Error Messages 220

Troubleshooting 229

Before Use

Basic Operations

Cutting Workflow

Maintenance

When problems occur

Appendix

Messages and Error Messages

Troubleshooting

# Messages and Error Messages

## When it appears

### Check the message/ error/ warning

To check the messages that are displayed while printer is working normally or the error/ warning that appears when a problem occurred, you will use MSM.

**1** Start MSM.  
👉 "Launching/ Opening/Exiting MSM" P.26

**2** Check [Status Information].

- The content of message/error/warning appears.
- If remedies for the problem are displayed, follow the instruction.

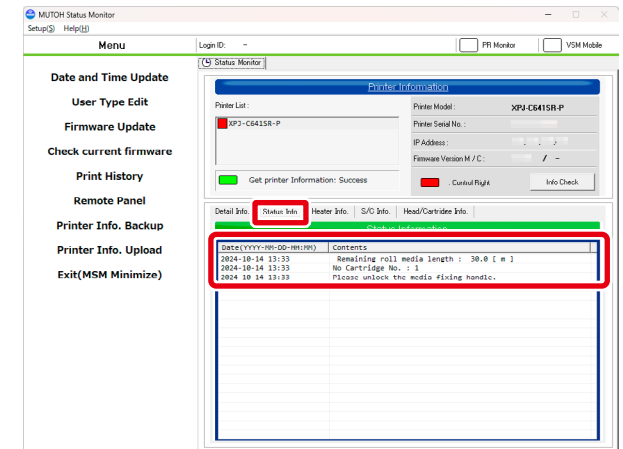

#### Note

- When the remote panel opens, you can check it from [Printer Status] - [Status Information].
- When an error occurs, the operation may be paused. It will resume after the cause of error is cleared.

## Message appeared on the control panel

The error LED on the control panel turns on.

- 1 Check the content of message on MSM and deal with it.  
 ["Check the message/ error/ warning" P.220](#)

## Error message appeared on the control panel

The error LED on the control panel turns on with beep sound. (For warning, it blinks)

- 1 If it keeps beeping, short press the operation key on the control panel.
  - The buzzer stops.

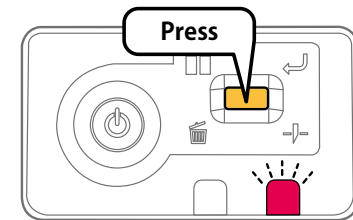

- 2 Check the content of error/warning on MSM and deal with it.  
 ["Check the message/ error/ warning" P.220](#)

## In the emergency mode

When a system error occurs, the data LED and error LED on the control panel blink concurrently and a beep sound continues at regular intervals.

- 1 Short press the operation key on the control panel.
  - The beep stops.

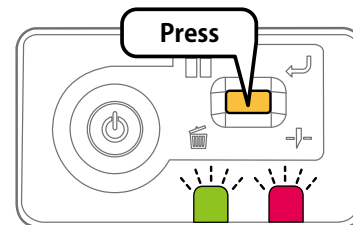

Before Use

Basic Operations

Cutting Workflow

Maintenance

When problems occur

Appendix

Messages and Error Messages

Troubleshooting

**2** Use MSM to check the content of the system error.  
☞ "Check the content of error in emergency mode" P.223

- If you could check the error content, move to [5].
- If you are unable to view the status monitor, move to [3].

**3** If you are unable to view the status monitor, short press the operation key on the control panel again.

- The LED flashes and the buzzer beeps in regular pattern. This pattern indicates the error code.

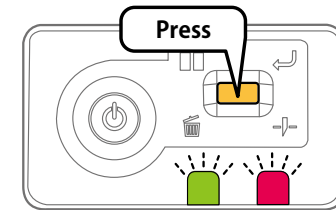

**4** Count the number of times the short buzzer beeps (or short LED blinks).

- The error code is three digits.
- The long buzzer indicates the digit of the error code and the short buzzer that beeps after long buzzer indicates the error code.
- For example, when the error code 154 occurs, it beeps as follows:
- Long buzzer: 3 times, Short buzzer: 1 time, Long buzzer: 2 times, Short buzzer: 5 times, Long buzzer: 1 time, Short buzzer: 4 times, Long buzzer: 3 times

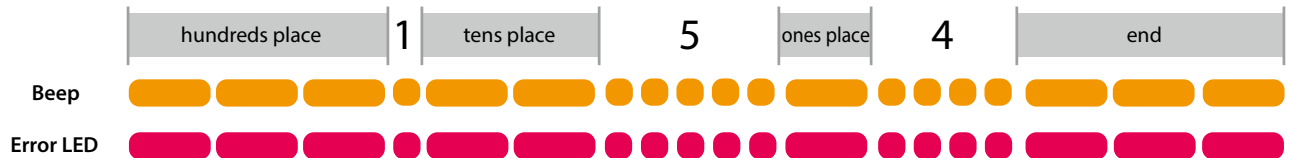

**Note**

- The pattern is not repeated. To check it again, short press the operation key on the control panel.
- If the error code for a digit is "0", only a long buzzer beeps, followed by a period of silence and then a long buzzer indicating the next digit beeps. The error LED also only blinks long and moves to the next long blink without a short blink.

Before Use

Basic Operations

Cutting Workflow

Maintenance

When problems occur

Appendix

Messages and Error Messages

Troubleshooting

**5** Check the points below:

- Open the front cover and check if the media is jammed. If yes, remove it.
- If there are any parts that you replaced, check that it is installed correctly.

**6** Turn off the machine and wait for more than 10 seconds.

Then turn it on. If the same error occurs, please contact your local MUTOH dealer.

## Check the content of error in emergency mode

**1** Start MSM.

☞ ["Launching/Opening/Exiting MSM" P.26](#)

**2** Check [Printer Information] and [Detail Info.].

- The content of system error and remedy are displayed.

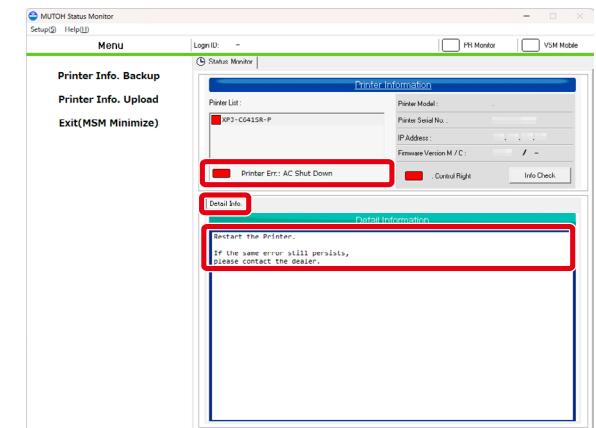

Before Use

Basic Operations

Cutting Workflow

Maintenance

When problems occur



Appendix

Messages and Error Messages

Troubleshooting

## Error messages and solutions

This section describes error messages and solutions to the messages. When an error occurs on the product, an error message will appear on MSM. The machine may stop operation depending on the error.

Display	Description
Cover Open	The front cover is open. Close it.
Lever Up	The media fixing handle is unlocked. Lock the handle.
Ink End No.****	The ink is out. (The machine will stop operation) Replace with a new ink cartridge.  <a href="#">"Replacing with a new ink cartridge" P.163</a>
S/C Card Error No.****	Unable to recognize the smartchip card. Insert the smartchip card correctly.
No Cartridge No.****	Ink cartridge is not loaded. (The machine will stop operation) Insert the ink cartridge.
Full WasteInkTank	The waste ink tank is full. (The machine will stop operation) Immediately drain the waste fluids into a container. Once emptying the tank, reset the waste ink counter to zero in MSM.  <a href="#">"Emptying waste ink tank" P.168</a>
Cartridge size unsupported. No.****	Unsupported cartridge is installed. Use a supported cartridge for this product.
Check that the ink cartridge is correctly installed. No.****	<ul style="list-style-type: none"><li>● <b>When using ink cartridges</b> Unable to recognize the ink cartridge correctly. Insert the ink cartridge again. If this error persists, contact your local MUTOH dealer.</li><li>● <b>When using high-capacity ink pack adapters</b> You have replaced with a new smartchip card, but probably forgot to replace the ink bag. Replace both smartchip card and ink bag in a set.</li></ul>



Before Use

Basic Operations

Cutting Workflow

Maintenance

When problems occur

Appendix

Messages and Error Messages

Troubleshooting

Check that correct color is correctly installed. No.\*\*\*\*

Ink cartridge is inserted into a wrong slot.  
Insert it into the correct slot.

S/C card Recognition Error No.\*\*\*\*

 ["Smartchip Recovery" P.228](#)

Pinch roller position check(Right):Media Edge

The pinch roller on the right hand side (origin side) is not positioned correctly.  
Position it on the edge of the media.

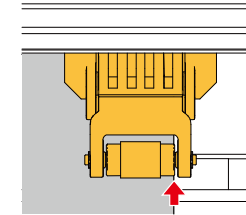

Pinch roller position check(Right):Grit roller projection

The pinch roller on the right hand side (origin side) is not positioned correctly.  
Position it over the protruding part of the grit roller.

 ["3. Loading the media into the machine" P.53](#)

Pinch roller position check(Left):Media Edge

The pinch roller on the left hand side (non-origin side) is not positioned correctly. Position it on the edge of the media.

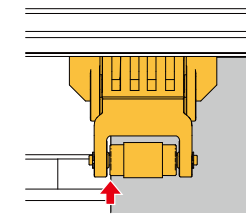

Pinch roller position check(Left):Grit roller projection

The pinch roller on the left hand side (non-origin side) is not positioned correctly. Position it over the protruding part of the grit roller.

 ["3. Loading the media into the machine" P.53](#)

Before Use

Basic Operations

Cutting Workflow

Maintenance

When problems occur

Appendix

Messages and Error Messages

Troubleshooting

Media Recognition Error

Failed to detect media. (The machine will stop operation)  
Reload media.

Media Slant Error

Media is skewed. (The machine will stop operation)  
Reload media.

Roll Media End

The machine has run out of media. (The machine will stop operation)  
Load a new roll media.

 ["Loading media into the machine" P.51](#)

Roll Media End(Print Stop)

The machine has run out of media. (The machine will stop operation)  
Load a new roll media.

 ["Loading media into the machine" P.51](#)

Crop mark read error(Media set error)

The machine may not be able to read the cropmarks if they are not positioned correctly. Set media so that the bottom edges of the two cropmarks on the front side are horizontal on the cutting mat.

 ["Step2. Cut" P.140](#)

Crop mark read error(Media Skew Error)

The machine may not be able to read the cropmarks properly if marks are skewed more than five degrees. Set media correctly.

 ["Step2. Cut" P.140](#)

Crop mark read error(Mark \* read error)

Check if the marks failed to read are not dirty or faint. The mark number (\*) corresponds to the detection order of cropmarks.

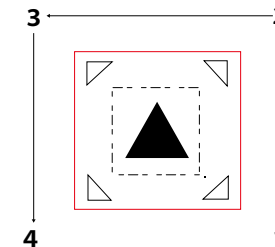

 ["Mark detection order" P.132](#)

Before Use

Basic Operations

Cutting Workflow

Maintenance

When problems occur

Appendix

Messages and Error Messages

Troubleshooting

No Media	Ready to print. (No media is loaded)
Discharged	The machine is not filled with ink. Perform initial ink charging to fill ink in the machine.
Life Times[CR Motor]	CR motor is nearing the end of life. (The machine will continue operation) Please contact your local MUTOH dealer or MUTOH customer service.
Life Times[PF Motor]	PF motor is nearing the end of life. (The machine will continue operation) Please contact your local MUTOH dealer or MUTOH customer service.
Life Times[Pump]	Pump motor is nearing the end of life. (The machine will continue operation) Please contact your local MUTOH dealer or MUTOH customer service.
Change Plg. No.****	High-capacity ink pack adapter has been used for a certain number of times. Replace with a new plug.
Contour cutting is not possible because the take-up device is in operation.	When doing contour cutting, remove media from the take-up unit and set the Output Mode to other than "Take up".
Unlock the media fixing handle and then remove media	Unlock the media fixing handle. If media is loaded in the machine, remove the media. Keep the handle unlocked when you are not using the machine.  <a href="#">"Media fixing handle" P.19</a>

Before Use

Basic Operations

Cutting Workflow

Maintenance

When problems occur

Appendix

Messages and Error Messages

Troubleshooting

## Smartchip Recovery

When the following message is prompted on MSM, a smartchip error such as broken chip may have occurred in the smartchip card. Check that the correct smartchip card is inserted and perform smartchip recovery. This will allow you to continue to print.

To perform smartchip recovery, do one of the followings according to the message appeared.

Display	Description
S/C Recog. E No.: ****	The smartchip card that needs smartchip recovery may have been installed. Remove the smartchip card and insert it again. If the printer is still unable to read it, insert a new smartchip card. <ul style="list-style-type: none"><li>• If a message [[**] Check Color OK -&gt;Enter] appears after the smartchip card is reinserted, follow the message [[**] Check Color OK -&gt;Enter] to operate.</li></ul>
Check Color No. : ****	The smartchip card that needs smartchip recovery may have been installed. Check that the ink color of the smartchip card inserted is correct. <ul style="list-style-type: none"><li>• In case of wrong color insertion, insert a correct smartchip card.</li><li>• If color is correct, press [Enter] key. The printer will perform smartchip recovery and will continue to print.</li></ul>

### Note

During smartchip recovery execution, the ink cartridge number being recovered is highlighted in yellow in the S/C information on MSM.

Before Use

Basic Operations

Cutting Workflow

Maintenance

When problems occur

Appendix

Messages and Error Messages

Troubleshooting

# Troubleshooting

This section describes machine troubles that an error message is not prompted, and possible cause and solutions.

## Note

- The printer status and error information can be checked from Status Information on MSM. If your printer is not operating correctly, check this Status Information first.
- Make sure to use the latest version of MSM. To check the latest available version, go to Help > Version > Check for updates on MSM. If old version is installed in your computer, download the latest version from MUTOH Club.  
☞ **Startup Guide "Downloading software"**.

## Installation and initial setup-related trouble

Symptoms	Possible causes and remedies
Cannot perform initial ink charging	Check that the front cover is closed.
	Lock the media fixing handle.
	Make sure ink cartridges are seated all the way in. ☞ <b>"Replacing with a new ink cartridge" P.163</b>
Ink does not come out after ink charging	Check that the ink cartridge is not too cold. <ul style="list-style-type: none"><li>• Rest the ink cartridge at room temperature for at least three hours, and perform head cleaning several times.</li></ul> ☞ <b>"Head cleaning" P.171</b>
	Did you turn off the power during ink charging? <ul style="list-style-type: none"><li>• If yes, turn the power ON and perform an initial ink charging again.</li></ul>

Before Use

Basic Operations

Cutting Workflow

Maintenance

When problems occur

Appendix

Messages and Error Messages

Troubleshooting

Symptoms	Possible causes and remedies
Nozzle clogging occurs after initial ink charging	<p>Did you perform head cleaning?</p> <ul style="list-style-type: none"><li>• Perform a head cleaning and then check the printout. 👉 <a href="#">"Head cleaning" P.171</a></li><li>• If there is no improvement in the printout even after performing cleaning, rest the printer for at least one hour. Then perform cleaning or "Little Charge" again and check the printout.</li><li>• If the problem still persists, contact your local Mutoh dealer.</li></ul>
MSM or RIP cannot access to the printer	Check that the Ethernet cable is connected securely to the Ethernet port.
	Check that the network settings are configured correctly.
	Check that the printer network settings match with the computer's settings. 👉 <a href="#">"Connecting to a Computer" P.23</a> , <a href="#">"Changing an IP address" P.28</a>

Before Use

Basic Operations

Cutting Workflow

Maintenance





When problems occur

Appendix

Messages and Error Messages

Troubleshooting

## Printer operation trouble

Symptoms	Possible causes and remedies
Printer does not work at all after powered on or even after media is loaded	Check that the power cord is plugged into the wall outlet.
	Does the AC power supply provide the specified voltage? • Connect the cable to another outlet.
	Check that the front cover is closed.
	Lock the media fixing handle.
	Check that the media is loaded into the printer correctly.  <a href="#">"Loading media into the machine" P.51</a>
	Check that the ink cartridges are inserted into the ink slots.
	Do you use the printer in the recommended environmental conditions? • Make sure to use the printer within the specification range.  <a href="#">Startup Guide "Check before installation"</a> .
Is there any error message displayed on MSM? • Check if an error message is displayed in the Status Information on MSM.  <a href="#">"Check the message/ error/ warning" P.220</a>	
Unable to power off the machine	Unlock the media fixing handle.
	Is there any error message displayed on MSM? • Check if an error message is displayed in the Status Information on MSM.  <a href="#">"Check the message/ error/ warning" P.220</a>

Before Use

Basic Operations

Cutting Workflow

Maintenance

When problems occur

Appendix

Messages and Error Messages

Troubleshooting

## Media-related trouble

Symptoms	Possible causes and remedies
Media slips, is torn or wrinkled during media initialization	Check that the media is loaded into the printer correctly. ☞ <a href="#">"Loading media into the machine" P.51</a>
	Are there any foreign materials such as torn paper on the pinch rollers? • Clean the pinch rollers. ☞ <a href="#">"Cleaning inside the machine" P.189</a>
	Do you use the printer in the recommended environmental conditions? • Make sure to use the printer within the specification range. ☞ <a href="#">Startup Guide "Check before installation"</a> .
	Are any curls or warps present on your media? • Place the edge holder on both edges of the media. • Check that you select the appropriate vacuum fan setting.
	Are you using a roll media that has fold, damage, torn or winding curls? • If yes, replace the media.
Printer does not detect media correctly during media initialization.	Check that the media is loaded into the printer correctly. ☞ <a href="#">"Loading media into the machine" P.51</a>
	Check that the media is not skewed. ☞ <a href="#">"Loading media into the machine" P.51</a>
	Do you use the printer in the recommended environmental conditions? • Make sure to use the printer within the specification range. ☞ <a href="#">Startup Guide "Check before installation"</a> .
	Did you load the media which has been printed before? • Use a new media.



Before Use

Basic Operations

Cutting Workflow

Maintenance

When problems occur

Appendix

Messages and Error Messages

Troubleshooting

Symptoms	Possible causes and remedies
Media jams frequently occur	Do you use the machine in the recommended environmental conditions? <ul style="list-style-type: none"><li>• Make sure to use the machine within the specification range. 👉 <b>Startup Guide "Check before installation"</b>.</li></ul>
	Are any curls or warps present on your media? <ul style="list-style-type: none"><li>• Set the edge holder at both edges of the media.</li><li>• Check that you select the appropriate vacuum fan setting.</li></ul>
	Are you using a roll media that has fold, damage, torn or winding curls? <ul style="list-style-type: none"><li>• If yes, replace the media.</li></ul>

 **Note**

If the media is jammed or torn, remove it according to "[The media is jammed](#)" P.242 .

Symptoms	Possible causes and remedies
The media is skewed during printing	Check that the media is loaded into the machine correctly. 👉 " <a href="#">Loading media into the machine</a> " P.51

Before Use

Basic Operations

Cutting Workflow





Maintenance

When problems occur

Appendix

Messages and Error Messages

Troubleshooting

Symptoms	Possible causes and remedies
Crop marks cannot be detected	<b>Are the cropmarks positioned correctly?</b> <ul style="list-style-type: none"><li>Set the media so that the bottom edges of the two cropmarks on the front side are horizontal on the cutting mat.  <a href="#">"Step2. Cut" P.140</a></li></ul>
	<b>Check that the media is not skewed.</b> <ul style="list-style-type: none"><li>The machine may not be able to read the cropmarks properly if marks are skewed more than five degrees. Set media correctly.  <a href="#">"Step2. Cut" P.140</a></li></ul>
	<b>Are the crop marks readable?</b> <ul style="list-style-type: none"><li>There are conditions that the color sensor is unable to detect the mark. Please check the following section.  <a href="#">"Step2. Cut" P.140</a></li><li>Check if the marks failed to read are not dirty or faint. The mark number (*) corresponds to the detection order of cropmarks.  <a href="#">"Mark detection order" P.132</a></li></ul>
	<b>Is the color sensor clean?</b> <ul style="list-style-type: none"><li>Clean the color sensor.  <a href="#">"Cleaning of color sensor" P.184</a></li></ul>

Before Use

Basic Operations

Cutting Workflow

Maintenance





When problems occur

Appendix

Messages and Error Messages

Troubleshooting

## Printing-related trouble

Symptoms	Possible causes and remedies
Machine does not print after data is sent	Check that the Ethernet cable is connected securely to the Ethernet port.  <a href="#">"Connecting to a Computer" P.23</a>
	Is there any error message displayed on MSM? <ul style="list-style-type: none"><li>• Check if an error message is displayed in the Status Information.</li></ul>
The carriage pauses at either side of the machine while printing	Does your computer meet the following requirements? <ul style="list-style-type: none"><li>• OS: Windows 11, Windows 10</li><li>• CPU: Intel (R) Core (TM) i5 or more</li><li>• Memory: No less than 16GB</li><li>• Network: Use a network port that supports Ethernet</li></ul>
	 <b>Note</b> <ul style="list-style-type: none"><li>• The OS support period of MUTOH software follows the Microsoft support lifecycle policies.</li><li>• When using RIP software, please also see the system requirements of your RIP software.</li></ul>
Smears or missing area partially appear on the prints	Are any curls or warps present on your media? <ul style="list-style-type: none"><li>• Place the edge holder on both edges of the media.</li><li>• Check that you select the appropriate vacuum fan setting.  <a href="#">"Loading media into the machine" P.51</a> , <a href="#">"Set up vacuum fan" P.99</a></li></ul>
	Does the media contain moisture or have fold or wrinkles? <ul style="list-style-type: none"><li>• If yes, replace it with the new media.</li></ul>
	Is there any dirt around the print head? <ul style="list-style-type: none"><li>• If yes, clean the parts around the print head.  <a href="#">"Cleaning the parts around the print head" P.177</a></li></ul>
The printing position is incorrect (partially not printed in some area).	Check that the media is loaded into the machine correctly.  <a href="#">"Loading media into the machine" P.51</a>

Before Use

Basic Operations

Cutting Workflow

Maintenance

When problems occur

Appendix

Messages and Error Messages

Troubleshooting

Symptoms	Possible causes and remedies
Printed line is blurred	Did you print on the printing side of media? • Check the printing side of media and load it correctly.
	Did you perform a print quality adjustment? • Perform a print quality adjustment. ☞ <a href="#">"Print quality calibration ("Adjust Print")" P.63</a>
	Did you perform a media feed adjustment? • Perform a media feed adjustment. ☞ <a href="#">"Media Feed Adjustment" P.71</a>
White or black lines appear on prints	Check that the media is loaded into the machine correctly. ☞ <a href="#">"Loading media into the machine" P.51</a>
	Does the media contain moisture or have fold or wrinkles? • If yes, replace it with the new media.
	Are nozzles in good condition? • Run a nozzle check. • If nozzle clogs, perform a head cleaning. ☞ <a href="#">"Nozzle check and cleaning" P.57</a>
	Did you perform a print quality adjustment? • Perform a print quality adjustment. ☞ <a href="#">"Print quality calibration ("Adjust Print")" P.63</a>
	Did you perform a media feed adjustment? • Perform a media feed adjustment. ☞ <a href="#">"Media Feed Adjustment" P.71</a>

Before Use

Basic Operations

Cutting Workflow





Maintenance

When problems occur

Appendix

Messages and Error Messages

Troubleshooting

Symptoms	Possible causes and remedies
Printed lines are not aligned/ doubled, Printout is faint.	<b>Are nozzles in good condition?</b> <ul style="list-style-type: none"><li>Run a nozzle check.</li><li>If nozzle clogs, perform a head cleaning.  <a href="#">"Nozzle check and cleaning" P.57</a></li></ul>
	<b>Did you perform a print quality adjustment?</b> <ul style="list-style-type: none"><li>Perform a print quality adjustment.  <a href="#">"Print quality calibration ("Adjust Print")" P.63</a></li></ul>
	<b>Did you perform a media feed adjustment?</b> <ul style="list-style-type: none"><li>Perform a media feed adjustment.  <a href="#">"Media Feed Adjustment" P.71</a></li></ul>
	<b>Is the ink within expiration date?</b> <ul style="list-style-type: none"><li>Use a non-expired ink.</li></ul>
Printed color is not accurate	<b>Are nozzles in good condition?</b> <ul style="list-style-type: none"><li>Run a nozzle check.</li><li>If nozzle clogs, perform a head cleaning.  <a href="#">"Nozzle check and cleaning" P.57</a></li></ul>
	<b>If you are using high-capacity ink pack adapters, did you install ink bags and smart chip cards in the correct combination?</b> <ul style="list-style-type: none"><li>Check if the combination is correct.</li><li>If it is wrong, perform a "Longstore" cleaning and then initial ink charging.</li></ul>
	<b>Is the ink within expiration date?</b> <ul style="list-style-type: none"><li>Use a non-expired ink.</li></ul>
Print doesn't dry easily	<b>Do you use the heater?</b> <ul style="list-style-type: none"><li>Check the heater settings.  <a href="#">"Specify the heater setting" P.101</a></li></ul>

 **Note**

- High ink coverage printing may take longer to dry.
- Depending on the media being used, ink may not dry easily.

Before Use

Basic Operations

Cutting Workflow

Maintenance

When problems occur

Appendix

Messages and Error Messages

Troubleshooting

Symptoms	Possible causes and remedies
Nozzle clogging persists even after head cleaning.	<p>Is the cleaning wiper dirty?</p> <ul style="list-style-type: none"><li>If yes, clean the cleaning wiper and the parts around the print head. ☞ <a href="#">"Cleaning the cleaning wiper" P.180</a> ,<a href="#">"Cleaning the parts around the print head" P.177</a></li></ul>
	<p>Did you select an appropriate cleaning mode?</p> <p>☞ <a href="#">"Head cleaning" P.171</a></p> <ul style="list-style-type: none"><li>Cleaning Mode: If nozzle clogging persists after attempting "Normal" or "Long" cleaning two or three times, perform "Little Charge".</li><li>Select Nozzle: If "Little Charge" does not recover the nozzles, go to the Select Nozzle menu and select the nozzles that are firing properly.</li></ul> <p>☞ MUTOH Status Monitor OPERATION MANUAL</p>
	<p>Is it time to replace the cleaning wiper or the pad for the flushing box?</p> <ul style="list-style-type: none"><li>Check the conditions of cleaning wiper and flushing box pad and replace them if required. ☞ <a href="#">"Replacing the flushing box pad" P.192</a> ,<a href="#">"Replacing the cleaning wiper" P.205</a></li></ul>

Before Use

Basic Operations

Cutting Workflow

Maintenance

When problems occur

Appendix

Messages and Error Messages

Troubleshooting

## Cutting-related trouble

Symptoms	Possible causes and remedies
Unable to perform cutting	Check that the cutter blade is attached to the blade holder. ☞ <a href="#">"Install a blade on the blade holder" P.111</a>
	Does the edge of the blade come out from the blade holder? • Adjust the blade depth. ☞ <a href="#">"Adjust blade depth" P.113</a>
	Is cutting force set properly? • Cutting cannot be performed correctly if cut force is too low. Adjust the cut force. ☞ <a href="#">"Run a test cut" P.118</a>
Cutting is not consistent	Did you perform cutting immediately after printing? • Cutting may not be consistent if print is not completely dried or media is hot. Specify the following settings. ☞ <a href="#">"Cooling down setting" P.103</a>
	Did you install the blade holder to the machine properly? • Check if the blade holder is secured properly in slot. ☞ <a href="#">"Install the blade holder into the machine" P.115</a>
	Did you change to a different type of media? • If yes, adjust the blade depth. ☞ <a href="#">"Adjust blade depth" P.113</a>
	Is the blade depth set properly? • Adjust the blade depth. ☞ <a href="#">"Adjust blade depth" P.113</a>
	Is cutting force set properly? • Run a test cut and adjust the cut force. ☞ <a href="#">"Run a test cut" P.118</a>
	Is cutting speed set properly? • Depending on the types of media, cutting with low speed can be more stable. Try a different cut speed setting. ☞ <a href="#">"Run a test cut" P.118</a>

Before Use

Basic Operations

Cutting Workflow

Maintenance

When problems occur

Appendix

Messages and Error Messages

Troubleshooting

Symptoms	Possible causes and remedies
(Continuing from the previous page) Cutting is not consistent	<b>Is the offset set properly?</b> <ul style="list-style-type: none"><li>Adjust the offset. ☞ <a href="#">"Run a test cut" P.118</a></li></ul>
	<b>Do you use a worn or damaged blade?</b> <ul style="list-style-type: none"><li>If it is worn, increasing the cut force by approximately 50gf from the original setting may improve cutting stability. If you can visually see the damage on the blade edge, replace with a new blade. ☞ <a href="#">"Adjust blade depth" P.113</a> , <a href="#">"Run a test cut" P.118</a> , <a href="#">"Replacing the blade for contour cutter" P.203</a></li></ul>
	<b>Is small pieces of media accumulated in the blade holder?</b> <ul style="list-style-type: none"><li>Clean the blade holder. If large amount of small pieces of media is accumulated immediately after cleaning, replace with a new blade. ☞ <a href="#">"Cleaning the blade holder" P.186</a> , <a href="#">"Replacing the blade holder" P.204</a></li></ul>
	<b>Is the surface of cutting mat worn or damaged?</b> <ul style="list-style-type: none"><li>Replace with a new cutting mat. ☞ <a href="#">"Replacing the cutting mat" P.201</a></li></ul>
Adjustment was done, but cuttings gradually become unstable.	<b>Do you use a worn or damaged blade?</b> <ul style="list-style-type: none"><li>If it is worn, increasing the cut force by approximately 50gf from the original setting may improve cutting stability. If you can visually see the damage to the blade edge, replace with a new blade. ☞ <a href="#">"Adjust blade depth" P.113</a> , <a href="#">"Run a test cut" P.118</a> , <a href="#">"Replacing the blade for contour cutter" P.203</a></li></ul>
	<b>Is small pieces of media accumulated in the blade holder?</b> <ul style="list-style-type: none"><li>Clean the blade holder. If large amount of small pieces of media is accumulated immediately after cleaning, replace with a new blade. ☞ <a href="#">"Cleaning the blade holder" P.186</a> , <a href="#">"Replacing the blade holder" P.204</a></li></ul>



Before Use

Basic Operations

Cutting Workflow

Maintenance

When problems occur

Appendix

Messages and Error Messages

Troubleshooting

Symptoms	Possible causes and remedies
Cutting position is incorrect	<b>Check that the media is not skewed.</b> <ul style="list-style-type: none"><li>To print and cut separately, the machine may not be able to read the crop marks if they are skewed more than 5 degrees. Load media properly. ☞ <a href="#">"Step2. Cut" P.140</a></li></ul>
	<b>Is there any dirt on crop marks?</b> <ul style="list-style-type: none"><li>To print and cut separately, the machine may not be able to read the crop marks if they are dirty. ☞ <a href="#">"Step2. Cut" P.140</a></li></ul>
	<b>Do you use colored media?</b> <ul style="list-style-type: none"><li>To print and cut separately, the machine may not be able to read the crop marks if the color of media is not white. ☞ <a href="#">"Step2. Cut" P.140</a></li></ul>
	<b>Is your media placed over the protruding part of the grit roller?</b> <ul style="list-style-type: none"><li>Check the position of the pinch rollers and the protruding parts of the grit rollers. ☞ <a href="#">"3. Loading the media into the machine" P.53</a></li></ul>
	<b>Is the contour cutting position adjusted properly?</b> <ul style="list-style-type: none"><li>Adjust the contour cutting position. ☞ <a href="#">"Adjust the contour cutting position" P.126</a></li></ul>
	<b>Is there any dirt on the bottom surface of the color sensor?</b> <ul style="list-style-type: none"><li>Clean the color sensor. ☞ <a href="#">"Cleaning of color sensor" P.184</a></li></ul>
	<b>Is the length of the output too long?</b> <ul style="list-style-type: none"><li>If it is too long, the cutting position can be easily misaligned.</li></ul>
Deep cut marks on the cutting mat	<b>Reduce the blade depth.</b> ☞ <a href="#">"Adjust blade depth" P.113</a>

Before Use

Basic Operations

Cutting Workflow

Maintenance

When problems occur

Appendix

Messages and Error Messages

Troubleshooting

## The media is jammed

**1** Press the power button on this machine.

- The blue lamp on the panel turns off.
- The machine begins powering off.

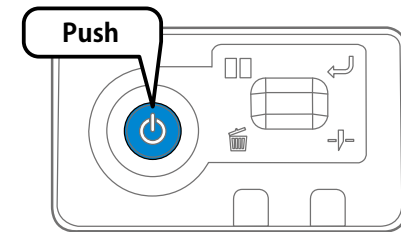

**2** Open the front cover.

**3** Raise the head height adjustment lever and change the print head height.

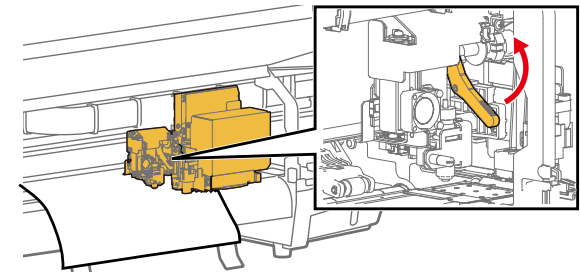

**4** Move the carriage on the media to the right side.

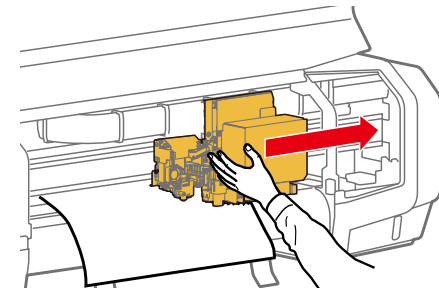

Before Use

Basic Operations

Cutting Workflow

Maintenance

When problems occur

Appendix

Messages and Error Messages

Troubleshooting

- 5 Turn the media fixing handle to unlock it.

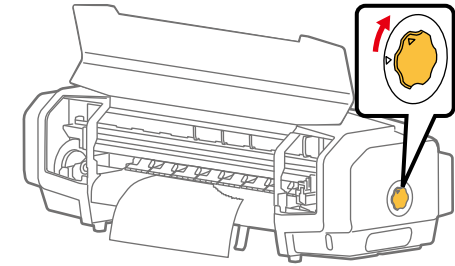

- 6 Pull out the media and cut the torn area with a cutter.

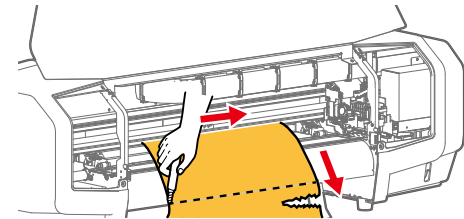

- 7 Hold both ends of the scroller and rewind the media onto the roll.

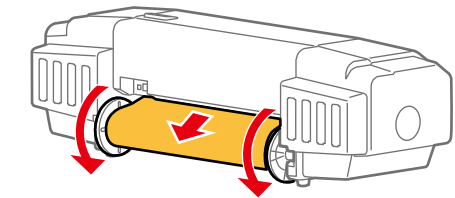

- 8 If paper dust or pieces of paper remain inside the machine, remove them.

# Appendix

<b>Specifications of this product</b>	<b>245</b>
<b>Optional accessories / Consumable supplies</b>	<b>247</b>
<b>Revision history</b>	<b>248</b>

Before Use

Basic Operations

Cutting Workflow

Maintenance

When problems occur

Appendix

Specifications of this product

Optional accessories / Consumable supplies

Revision history

# Specifications of this product

Name	Description	
Model name	XPJ-C641SR-P	
Printing method	On demand piezo method	
Driving method	Firmware servo/ DC motor drive	
Media feed method	Straight media feed, Roll media: load from the rear of the machine and eject from the front side. Face-out winding media only	
Media hold-down system	Pinch roller down system by media fixing handle	
Media size	Roll outer diameter	up to 150 mm
	Paper core diameter	2 inches or 3 inches
	Weight	up to 9 kg
	Width* <sup>1</sup>	<ul style="list-style-type: none"><li>• 198 to 228 mm</li><li>• 283 to 313 mm</li><li>• 344 to 374 mm</li><li>• 394 to 424 mm</li><li>• 444 to 474 mm</li><li>• 494 to 524 mm</li><li>• 602 to 630*<sup>2</sup>mm</li></ul>
	* <sup>1</sup> Common to both cut sheet and roll paper. * <sup>2</sup> Maximum width (For a roll media, width of paper core or media whichever is greater).	
	Maximum thickness	Head height "Low": up to 0.4 mm (Maximum thickness that media can pass through the media path: 0.8 mm)
Maximum printable width	600 mm	
Media cutting method	Auto cutting or manual cutting	
Heater	Built in the back side of media guide, Off / 30°C to 45°C	
Head height adjustment	Two options: Low and High	
CPU	64-bit RISC CPU	
Memory	256MB	

Before Use

Basic Operations

Cutting Workflow

Maintenance

When problems occur

Appendix

Specifications of this product

Optional accessories / Consumable supplies

Revision history

Name	Description	
Interface	Ethernet (10BASE-T / 100BASE-TX)	
Ink	Color	4 colors (Black, Cyan, Magenta, Yellow)
	Type	220 ml cartridge/ 1000 ml ink bag (Black, Cyan, Magenta, Yellow)
Waste ink tank	1400 ml tank is attached to the printer. Empty the tank when needed.	
Environmental conditions	Printer Operation Environment	Temperature: 20 to 32°C Humidity: 40 to 60% (no condensation)
	Printing accuracy guaranteed range	Temperature: 22 to 30°C Humidity: 40 to 60% (no condensation)
	Change rate	Temperature: within 2°C per hour Humidity: Less than 5% per hour (no condensation)
	Storage condition	<ul style="list-style-type: none"><li>Without ink filled: within 6 months Temperature: -20°C to 60°C , Humidity: 20% to 80% No condensation</li><li>With ink filled: within 1 week* *32 °C or above, within 4 days Temperature: -10°C to 40°C , Humidity: 20% to 80% (no condensation)</li></ul>
Power supply specifications	Voltage	AC 100 V to 120 V ± 10% or 200 V to 240 V ± 10%.
	Frequency	50 Hz / 60 Hz ± 1 Hz
	Current	6.5 A or more
	Voltage switch	Manually switch between 115 V/230 V by switch (Factory default is set to 230 V)
Power consumption	Power off	100 V AC to 120 V AC, 1 W or below 200 V AC to 240 V AC, 1.1 W or below
	Operation	215 W (Peak 800 W or less)
Current Consumption	100 V to 120 V	6.5 A or below
	200 V to 240 V	3.5 A or below
Dimensions	Height	366 mm (With stand installed: 1,166 mm)
	Width	1,190 mm
	Depth	438 mm (With stand installed: 590 mm)
Mass	Main unit	34 kg
	Stand	8.7 kg (VJ628-STD), 10.2kg (IJ-STDX-01)

Before Use

Basic  
Operations

Cutting  
Workflow

Maintenance

When problems  
occur

Appendix

Specifications of this product

Optional accessories /  
Consumable supplies

Revision history

# Optional accessories / Consumable supplies

For information about optional accessories and consumable supplies, please contact your local MUTOH dealer.

Before Use

Basic Operations

Cutting Workflow

Maintenance

When problems occur

Appendix

Specifications of this product

Optional accessories / Consumable supplies

Revision history

# Revision history

Date	Version	Manual	Supported Firmware
2024.10	00	XPJC641SRPE-A-00	V 1.00
2025.1	01	XPJC641SRPE-A-01	V 1.03 or later